

# Pearl®

2019 GENERAL CATALOG







# THE PEARL EXPERIENCE.

It's more than just hitting things and keeping time. It's a percussive pulse that connects you with an instrument so personal and precise it's backed by the best quality promise in our industry. It's a community

of drummers and drum crafters united by a passion for performance, efficient elegance, and timeless design. Innovating since 1946 to make your voice heard, Pearl is the Best Reason to Play Drums.

## MASTERWORKS



### COMPLETELY CUSTOM, TOTALLY HANDMADE.

A custom-tailored heirloom instrument, hand crafted from a seemingly endless array of marquee components for the drummer who wants ultimate control. *Pages 2 - 11*

## REFERENCE



### SONICALLY SELECT DRUM PERFORMANCE.

Each Reference drum is individually engineered with premium Masterworks materials, delivering optimum sound and projection for the power player. *Pages 12 - 13*

## REFERENCE PURE



### UNRESTRICTED TONAL RESPONSE.

The individually engineered Reference Recipe in a lighter, thinner drum shell format for close field articulation and a warm, resonant vibe. *Pages 14 - 15*

## SESSION STUDIO SELECT



A COMPLETELY NEW TAKE ON THE FULL SPECTRUM SOUND. A premium shell combination of Masters grade Birch and African Mahogany brings a radically unique sonic blend of preEQ'd warmth, and articulate punch. *Pages 28 - 29*

## CRYSTAL BEAT



THE ORIGINAL SEAMLESS ACRYLIC DRUM SHELL. With unparalleled visual clarity and straight tone punch, Crystal Beat shells are precision molded for a strikingly unique drumming signature. *Pages 30 - 31*

## DECADE MAPLE



A DRUM KIT 10 YEARS IN THE MAKING. With 5.4mm Maple shells, pro level features, and gorgeous lacquer finishes, Decade elevates your performance at a price that was previously impossible. *Pages 32 - 33*

## MASTERS MAPLE RESERVE



### A CLASSIC FORMULA FOR SONIC GREATNESS.

Delivers a balanced tonal combination of rich lows and wide open resonance, for lively sonic character fit for the most discerning musical pallet. *Pages 22 - 23*

## MASTERS MAPLE GUM



### LIMITED EDITION, UNLIMITED SOUND.

The artist-preferred, recording optimized Masterworks Sonic Select: Studio shell formula; available in a focused, short run premium selection for a limited time. *Pages 24 - 25*

## MASTERS MAPLE COMPLETE



### THE MASTERS SHELL COMES FULL CIRCLE.

The road proven Masters legend shines forward with the extended tuning range of Pearl's EvenPly 6-layer Maple shell and premium lacquer finishes. *Pages 26 - 27*

## EXPORT / EXPORT LACQUER



### THE BEST SELLING DRUM SET OF ALL TIME.

The kit that spawned a thousand drumming legends is built better than ever to give a strong beginning to the new drummer's lifetime of play. Available in covered or high gloss lacquer finishes. *Pages 34 - 35*

## MIDTOWN



### BIG GIG, SMALL RIG, HUGE SOUND.

Essential for the metropolitan player, Midtown's ultra portable, complete shell pack delivers full size play in a small footprint for rich, powerful groove on the go. *Page 36*

## ROADSHOW / ROADSHOW JR.



### IT'S YOUR TIME TO PLAY. START THE RIGHT WAY!

A drum set package complete with everything needed (drums / hardware / cymbals / extras) to start drummers of all ages on their rhythmic journey. *Page 37*

## THE BEST WARRANTY IN THE INDUSTRY! \*



COMMITTED TO THE HIGHEST LEVEL OF CUSTOMER SATISFACTION.

- Drum Set/Concert wood and metal shells for the Lifetime of the Original Owner.
  - Foot pedals, hi-hat stands, cymbals stands, boom cymbal stands, snare drum stands, throne bases, floor-standing tom stands, floor-standing cymbal/tom stands, concert stands, racks and rack accessories, cymbal holders and multi-clamps for the Lifetime of the Original Owner. Some exceptions apply.
  - Drum Set claws, tension rods, swivel nuts, spurs, tom brackets, tom holders, strainers, and nuts and bolts for the Lifetime of the Original Owner.
  - Rotationally molded cases for the Lifetime of the Original Owner.
  - The Lifetime Warranty applies to the aforementioned Pearl products purchased from June 15, 2009.
- \* This Lifetime Warranty is valid only in the United States and excludes the Crystal Beat and Roadshow Series.

The Pearl Lifetime Warranty is a statement of confidence to our customers to the reliability of Pearl products. Pearl drums, stands and hardware are designed and manufactured to the highest standards in quality, style, appearance and playing performance. This lifetime warranty reflects a tradition of excellence and a commitment to superior engineering and craftsmanship dedicated to you, the drummer. The Pearl lifetime warranty is our pledge to you that we will proudly stand behind our product for as long as you own it. *Buy it once, play it for life.*

DRUM SETS	ELECTRONIC SERIES	HARDWARE	PERCUSSION
2-11 Masterworks	38-39 e/MERGE	50-51 Demon Drive / Chain	68-69 Signature Series
12-13 Reference	40 MIMIC PRO	52-53 Eliminator Redline	70-71 Congas & Bongos
14-15 Reference Pure	41 malletSTATION	54-55 P930 / P932	72-73 Cajons & Accessories
16-21 Music City Custom		56 P920 / P922	74 Timbales / Rainsticks
22-23 Masters Maple Reserve		57 P530 / P830	75 Cowbells / Tongue Drums
24-25 Masters Maple Gum	<b>SNARE DRUMS</b>	58-59 Hi-Hat Stands	76 Djembes
26-27 Masters Maple Complete	42-43 Reference	60 Snare Stands	77 Folkloric / Brazilian
28-29 Session Studio Select	42-43 Series Component	61 Drum Thrones	78 Concert Percussion
30-31 Crystal Beat	44 Free Floating	62-63 Cymbal Stands	79 Hand Percussion
32-33 Decade Maple	45 Hybrid Exotic	64-66 Racks / Accessories	80-81 Percussion Stands, Bags, & Holders
34 Export Lacquer	46 SensiTone	67 Tom Stands / Arms	
35 Export	47 SensiTone Premium		
36 Midtown	48-49 Signature		
36 Compact Traveler	48 Modern Utility	<b>PARTS, ARTISTS, CONFIGS</b>	
37 Roadshow	49 Utility & Effects	82-83 Replacement Parts	88-Back Color & Configuration Chart
37 Roadshow Jr.		84-87 Pearl Artists	





“You should be in love with your drums. If you are not, you have some questions to ask yourself. For me, I want to feel like a kid on Christmas morning when I sit down to play. My Masterworks drums give me that feeling, every time. I could play any drums I choose, and I have a collection, but when it comes down to business in the studio or on the road - I choose Pearl.”

TODD SUCHERMAN  
STYX



**M**  
*Masterworks*  
20th ANNIVERSARY

**Pearl**

MASTERWORKS SONIC SELECT STUDIO RECIPE KIT  
WITH GLOSS SUNBURST STRIPE LACQUER FINISH  
OVER ARTISAN FLAME MAPLE VENEER.



# MASTERWORKS

*Completely Custom.  
Totally Handmade.*



## DRUMMING WITHOUT LIMITS

The first to offer sound sculpting, boutique level drum customization to the pro drummer on a grander scale, Masterworks gives you the freedom to design a drum kit worthy of your drive for excellence.

## THE MASTERWORKS DIFFERENCE

Selecting the right combination of our finest hand selected shell veneers with the precision engineering of our premium hardware appointments, Masterworks gives you the freedom to customize a sound that is completely your own.

Customize your own signature sound with shell plies from four premium wood types. Combining wood types blends each material's sonic character.

### SHELL MATERIALS

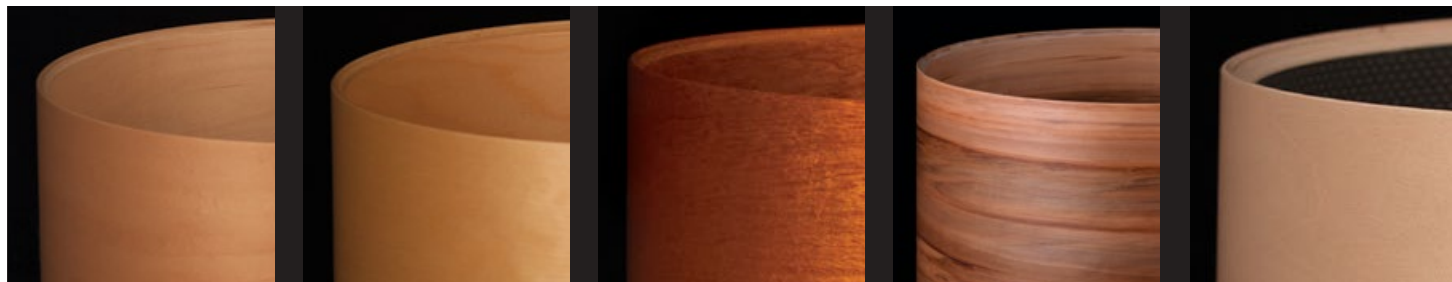

- MAPLE**  
*The perfect blend of tone, attack, and body.*  
Equal tonal amounts of highs, mids, and lows.
- BIRCH**  
*"Built-in EQ" delivers articulate stroke with shorter, even decay.*  
Boosted highs and mellow mid-level tone.
- AFRICAN MAHOGANY**  
*The perfect blend of tone, attack, and body.*  
Equal tonal amounts of highs, mids, and lows.
- GUMWOOD**  
*Explosive projection and increased volume.*  
Equal tonal amounts of highs, mids, and lows.
- CUSTOM INTERIOR**  
*The Ultimate Hybrid.*  
Expand the tonal spectrum by configuring any of Pearl's exotic exterior hardwoods, or a thin layer of hand applied carbon fiber or fiberglass to the shell interior.

### SHELL SIZE AND THICKNESS

Virtually every standard shell diameter is available in customizable depths, with a choice of shell thicknesses for precise tonal character, sustain, and projection.

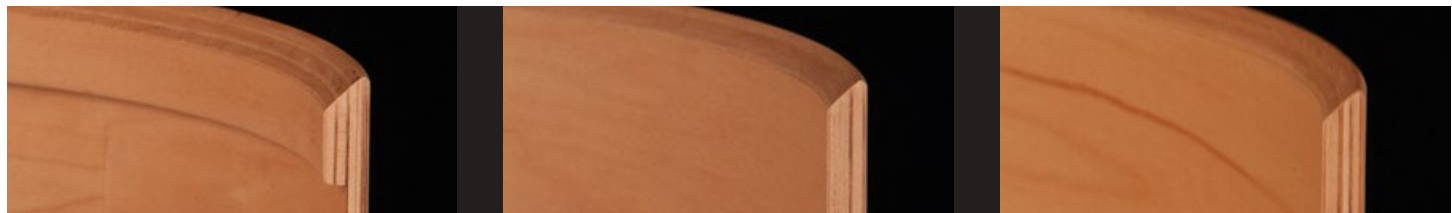

- THIN (4-ply, 5mm w/ 4-ply Reinforcement Rings)**  
Increased sustain and low-end.
- MEDIUM (6-ply, 7.5mm)**  
Full-bodied tonal projection ideal for general purpose.
- THICK (8-ply, 10mm and 10-ply, 12.5mm)**  
Maximum projection and quick decay.

### FINISHES

Like commissioning fine artwork, the Masterworks Custom Shop is ready to follow your lead in hand finishing your perfect visual statement.

- LUXURY** - Includes a choice of High Gloss, Satin Stain, and Sparkle Lacquer
- CUSTOM** - Includes Pinstriping, Banding, Artisan II Custom Graphics
- ARTISAN** - Includes a choice of transparent finishes over exotic veneers (*shown below*)



- CAMEROON BLACK LIMBA**
- FLAME MAPLE**
- AFRICAN ZEBRA WOOD**
- TAMO ASH**
- WATERFALL BUBINGA**
- EUCALYPTUS**
- CARBONPLY**

### BEARING EDGE

Masterworks offers a choice of five sonically tested edges - configurable by drum, application, and shell side.



- STANDARD 45°**  
Provides the perfect blend of attack and warmth.
- OUTER 60°** Pulls brighter overtones and increases punch.
- INNER 45°** Edge apex focused to inner shell plies for controlled sustain.
- ROUNDED 45°** Increased head-to-shell contact boosts mids and highs.
- FULLY ROUNDED**  
Boosts mid-to-low range response and reduces decay.

### HARDWARE FINISH, LUG, AND HOOP OPTIONS

Choose from five gorgeous plating options on your selection of our precision tuning lugs, hoops, and drum hardware.

#### LUGS

- Bridge (CL100)
- Single Swivel (STL100)
- Swivel Tube (STL150)
- Swivel Arch (BRL100)

#### FINISHES

- CHROME** (Shown w/ CL100 Lug)
- NICKEL** (Shown w/ STL100 Lug)
- GOLD** (Shown w/ STL150 Lug)
- BLACK CHROME** (Shown w/ BRL100 Lug)
- BLACK NICKEL** (Shown w/ STL150 Lug)

#### HOOPS

- MASTERCAST DIE-CAST**
- 2.3MM SUPERHOOP II**
- FATTONE**



MASTERWORKS CUSTOM KIT  
IN SATIN SLATE FINISH OVER BLACK LIMBA A2 VENEER  
WITH BLACK CHROME HARDWARE

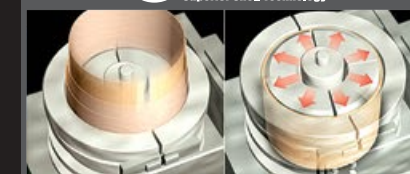

### SUPERIOR SHELL TECHNOLOGY - Elite Sound, Strength, and Workmanship: Guaranteed.

The first high temperature hydraulic shell curing process of its kind in drum making, SST continues to be a standard for extreme strength and optimum resonance.

All shells are formed in a bonded combination of cross-laminated two-ply veneer panels; precision milled with overlapping scarf joint seams and cured with our exclusive AcoustiGlue at 1000 PSI of hydraulic pressure.



# MASTERWORKS

## Sonic-Select Shell Recipe: URBAN



THE FULL SPECTRUM OF  
MASTERWORKS CHOICE IN  
SHARP FOCUS

Five distinct drum recipes; each one a combination of sonically proven shell woods, edge profiles, and precision hardware options. Crafted to create a truly unique tonal signature.

### URBAN (pgs. 6 - 7)

A thin, powerful shell blend for the precise metropolitan drummer.

**STADIUM**  
(pg. 8) Pearl's thick CZX Maple shell for high-volume power.

**STUDIO** (pg. 10)  
Explosive tonal clarity and articulation for recording.

**HERITAGE**  
(pg. 9) Classic drum feel with enhanced lows and fat top-end slap.

**MODERN DRY**  
(pg. 11) Quick, top-heavy articulation with controlled low-end.



# URBAN

Urgent, powerful, and defiant, the *Urban Recipe* projects loudly on the top-end and fills the bass frequencies with thunderous, shaking lows. From the arenas to the modern sanctuary, this is Masterworks for a new breed of top players.



Listen to the Urban recipe played by Brian Frasier Moore at [pearldrums.com](http://pearldrums.com)



MASTERWORKS SONIC SELECT URBAN RECIPE KIT IN SATIN BLACKBURST WHITEWASH OVER BLACK LIMBA A2 VENEER.

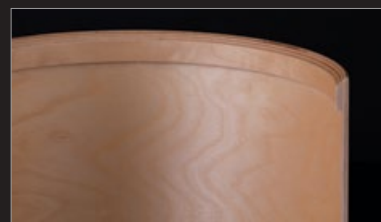

### SHELL

EvenPly-6; 2-Birch/2-Gumwood/2-Birch with 4-ply Maple Reinforcement Rings (8-ply Snare Drums; 2 Birch / 4 Gumwood / 2 Birch). Perfectly captures each stroke with articulate high-volume punch and quick, even decay.

### BEARING EDGE

Rounded 45° on Toms (Fully Rounded edge on bass drums, standard 45° on snare drums). Boosted mid and high-end frequencies in toms, subdued sustain and maximized low-end in the kick.



### HARDWARE

2.3mm Superhoop II Hoops - Made for heavy play without limiting tuning range performance.



### STL SWIVEL LUGS

A medium-weight lug with pivoting tension casing for increased projection and reduced overtone. STL150 / 300

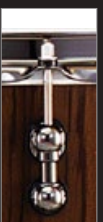



## MASTERWORKS

*Sonic-Select Shell Recipe:*  
**STADIUM**

### SHELL

10 ply Maple Bass Drums and Floor Toms, 8 ply Maple Toms and Snare Drums. A thick shell for maximum power and drive.

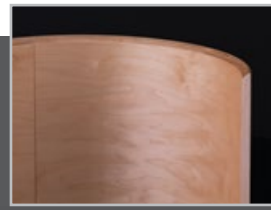

To explore the all new options for Pearl's ICON Rack systems, see p.64-66.



## STADIUM

Sonic-Select Stadium is the total solution for dominating volume and articulate attack. Its high density shell and hardware combination speaks with a commanding presence; projecting with full bodied midrange and focused low end sonic authority.

*MASTERWORKS SONIC SELECT STADIUM RECIPE KIT*  
IN GLOSS A2 CUSTOM GRAPHIC (FEATURING SELECTIONS FROM "CAIN & ABEL: THE OFFERING" BY ILLUSTRATOR JESSICA HANCOCK) OVER NATURAL MAPLE WITH BLACK NICKEL-PLATED HARDWARE.

### BEARING EDGE

Outer 60° - Increases brightness and power with controlled overtone.



### HARDWARE

2.3mm Superhoop II Hoops - Made to withstand heavy play while allowing the shell to breathe.



### BRL SWIVEL LUGS

Assures the ultimate in head seating and tuning integrity.  
BRL100 / 300

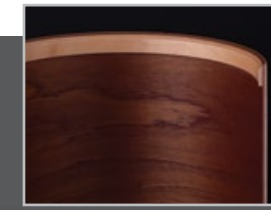

### SHELL

4 Ply, 2 Ply Maple outside and 2 Ply Mahogany inside with 4-ply Maple Reinforcement Rings - A traditional blend of midrange punch and boosted low-end.

## MASTERWORKS

*Sonic-Select Shell Recipe:*  
**HERITAGE**



### A2 CUSTOM FINISH GRAPHICS

Turning the drum shell into a blank canvas, Pearl employs an industry exclusive method to print a choice of high definition graphics directly onto the outer shell ply without affecting the tone or structure of the drum. Consult your authorized Pearl Dealer for more information.



## HERITAGE

The Heritage Recipe's robust organic presence responds like the growl of a classic roadster. Its thin, reinforced shell produces thunderous sub-bass frequencies with exceptional sustain and subtle projection.

*MASTERWORKS SONIC SELECT HERITAGE RECIPE KIT*  
MATTE A2 NATURALBURST GRAPHIC (FEATURING SELECTIONS FROM "CAIN & ABEL: THE OFFERING" BY ILLUSTRATOR JESSICA HANCOCK) OVER ARTISAN WATERFALL BUBINGA VENEER WITH NICKEL-PLATED HARDWARE.

### BEARING EDGE

Standard 45° - A precise low-contact edge that adds projection and resonance to darker toned shells.



### HARDWARE

FatTone Hoops - Extends sustain similar to the vintage "stick-chopper" with a light, rigid design that increases tuning stability.



### SINGLE STL SWIVEL LUGS

A small pivoting brass tension casing efficiently evens tuning and reduces shell resistance.  
STL100 / 200





## MASTERWORKS

*Sonic-Select Shell Recipe:*  
**STUDIO**

### STUDIO *Masterworks*

A consistent, commanding sonic foundation for any genre in the recording environment, Studio Recipe's hardware/shell combination gives it explosive projection in the midrange, for clean tonality with extended low-end punch.



#### SHELL

EvenPly-6, 4-ply Maple outer with 2-ply Gumwood inside – A thin, resonant combination of a hard exterior with milder tonewood for explosive low-range warmth.



*Listen to the Studio Recipe played by Shannon Forrest of Toto at [pearldrums.com](http://pearldrums.com)*



#### SHELL

2-ply Maple outer / 2-ply Gumwood inner with 4 ply Mahogany Reinforcement Rings. A thin shell with a softer re-ring and tonewood for added bottom-end focus.



*Listen to Modern Dry played by Will Kennedy of the Yellowjackets at [pearldrums.com](http://pearldrums.com)*

## MASTERWORKS

*Sonic-Select Shell Recipe:*  
**MODERN DRY**

### MODERN DRY

The Modern Dry Recipe blends three sonically unique tone woods for a controlled tone and dark, pillowy response. Its subdued restraint is excellent for driving, organic stylings.



*MASTERWORKS SONIC SELECT STUDIO RECIPE KIT WITH GLOSS SUNBURST STRIPE LACQUER FINISH OVER ARTISAN FLAME MAPLE VENEER.*



*MASTERWORKS SONIC SELECT MODERN DRY RECIPE KIT IN SATIN AZURE FADE LACQUER FINISH OVER ARTISAN ZEBRAWOOD VENEER WITH GOLD-PLATED HARDWARE.*

*For a complete listing of ICON Drum Racks and Parts, see Pages 64-66*

#### BEARING EDGE

Outer 60° – Gives increased power and bite to a thinner hybrid shell.



#### HARDWARE

MasterCast Hoops – Escalates weight for tonal body and increases volume in high velocity play



#### CL BRIDGE LUGS

A classic look with minimal shell contact at separate points for precise vibration control. CL100 / 250



#### BEARING EDGE

Inner 45° – Its inner shell apex contacts the head inside the shoulder for focused control in low tunings.



#### HARDWARE

MasterCast Hoops – Gives each drum added weight for increased volume and controlled sustain.



#### STL SWIVEL LUGS

A classic look with minimal shell contact at separate points for precise vibration control. CL100 / 250





## REFERENCE

*Sonically Select  
Drum Performance.*

### REFERENCE SERIES: INDIVIDUALLY ENGINEERED, INCREDIBLE SOUNDING DRUMS.

Pearl changed the drum set forever with the introduction of Reference Series in 2005. Utilizing the nearly limitless selection options from our Masterworks series, the Reference Recipe's individually engineered drum formula creates a completely retooled drum set playing experience of power, tone, and play.

Like individual notes on a piano, each Reference drum is configured for its intended size and sound with a combination of pristine shell woods, precision hardware fittings, and edge profile. The total Reference kit produces a singular, unified sound that perfectly captures every nuance of your unique drumming identity.

RF924XEDP/N\*\*\*  
#835 AGED HONEY BURST



See full Color Chart on back cover for all Special Order Finishes.  
\*\*\*Nickel and Black Nickel hardware available at premium charge.









## THE REFERENCE DIFFERENCE

All drums are not created equal. So why make them all with the same wood type and edge? Reference toms, snares, and bass drums each have a different 'recipe' for their specific application and voice.



#376 ULTRA BLUE FADE

To find out about this and other  
ICON RACK RECIPES, go to  
[www.pearlrackrecipes.com](http://www.pearlrackrecipes.com)

REFERENCE RECIPE	SHELL TYPE	BEARING EDGE	SONIC OUTPUT
8" and 10" Toms	 <b>Maple(4)/Birch(2)</b> 6-ply (RF 7.5mm / RFP 5.4mm)	Rounded 45°	Extra cut and projection for high-note pitch
12" Toms	 <b>Maple(6)</b> 6-ply (RF 7.5mm / RFP 5.4mm)	Rounded 45°	Transitional mid-note; blend of warmth and cut
13" Toms	 <b>Maple(4)/Mahogany(2)</b> 6-ply (RF 7.5mm / RFP 5.4 mm)	Rounded 45°	Top-end slap with added low/bottom end
14" and 15" Toms	 <b>Maple(4)/Mahogany(2)</b> 6-ply (RF 7.5mm / RFP 5.4 mm)	Fully Rounded	Bracing low-end with extended sustain
16" Toms	 <b>Maple(2)/Mahogany(4)</b> 6-ply (RF 7.5mm / RFP 5.4mm)	Fully Rounded	Bracing low-end with extended sustain
14" Floor Toms	 <b>Maple(4)/Mahogany(4)</b> 8-ply (RF 10mm / RFP 7.2mm)	Fully Rounded	Bracing low-end with extended sustain
16" and 18" Floor Toms	 <b>Maple(2)/Mahogany(6)</b> 8-ply (RF 10mm / RFP 7.2mm)	Fully Rounded	Bracing low-end with extended sustain
18" and 20" Bass Drums	 <b>Maple(2)/Mahogany(4)</b> 6-ply (RF 7.5mm / RFP 5.4mm)	Fully Rounded	Enhanced sub-frequency response
22", 24", 26" Bass Drums	 <b>Maple(2)/Mahogany(6)</b> 8-ply (RF 10mm / RFP 7.2mm)	Fully Rounded	Booming bass tone with articulate punch

Shell: Maple, Birch & African Mahogany  
Snare: 20 Ply Matching 13 x 6.5, 14 x 5 or 14 x 6.5\*  
Finish: Super High Gloss Lacquer / Lacquer Sparkles  
Heads: Remo Clear Emperor Tom, Powerstroke3 Bass  
Tom Mounts: Aluminum OptiMount Suspension System  
Tom Arms: Sold Separately  
Drum Hardware: Chrome, Nickel, Black Chrome Plated or Gold Plated  
Hoops: MasterCast Die-Cast Hoops  
Lugs: BRL Bridge Lugs with Swivel Function  
\*Sold Separately

### REFERENCE SNARE DRUMS

A staggeringly thick 20-ply shell (comprised of six inner Birch plies and 14 outer plies of Maple,) with a 45° bearing edge projects with the volume and articulation you'd expect without losing sensitivity or body.



### HARDWARE

Engineered to enhance each shell rather than restrain it, Reference BRL Swivel Lugs and Mastercast die-cast hoops increase function and tuning integrity; adding weight to the shell for articulate output boost.

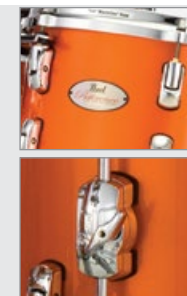

Our telescoping bass drum spurs feature a retractable high-grip rubber tip with a recessed spike for maximum "bite" on carpeted surfaces.

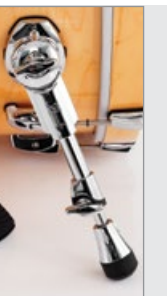



# REFERENCE PURE

*Unrestricted Tonal Response.*



#102 NATURAL MAPLE

To find out about this and other  
ICON RACK RECIPES, go to  
[www.pearltrackrecipes.com](http://www.pearltrackrecipes.com)

## THE REFERENCE PURE DIFFERENCE

Reference Pure drums present an uninhibited, shell focused tonality for the in demand drummer. Boasting the same shell construction that made Reference drums a professional standard, Reference Pure's ultra thin EvenPly shell reduces shell weight and thickness by 30%; for increased resonance and improved bottom end that responds immediately in any playing environment.

- 1.6mm FatTone Hoops' exclusive hemmed/welded edge (U.S. Pat. #8367917) gives increased strength to low-mass design.
- STL Swivel Tube Lugs allow for increased resonance, minimal shell contact, and precisely aligned, no bind tuning.

Shell: Low Mass EvenPly Maple, Birch & African Mahogany  
Snare: 6 Ply Matching 13 x 6.5, 14 x 5, 14 x 6.5\*  
Finish: Super High Gloss Lacquer / Lacquer Sparkles  
Heads: Remo Clear Emperor Tom, Powerstroke3 Bass  
Tom Mounts: Aluminum OptiMount Suspension System  
Tom Arms: Sold Separately  
Hardware: Chrome, Nickel, Black Chrome Plated, or Gold Plated  
Hoops: Low Mass FatTone Hoops  
Lugs: Low Mass STL Swivel Tube Lugs

*\*Sold Separately*

*See full Color Chart on back cover for all Special Order Finishes.*

*\*\*\*Nickel and Black Nickel hardware available at premium charge.*



RFP943XPC  
#830 AUTUMN FADE SPARKLE

### SHELL

Using the same shell composition formula as the original (number and type of wood plies, task-specific bearing edges, etc.) the highly resonant qualities of Reference Pure's lower-mass, thinner shell assure an uninhibited shell-focused tonality that responds immediately in any playing environment.



### SNARE DRUMS

A thin EvenPly-6 shell with four outer Maple and two inner Birch plies for cut, projection, and smooth, balanced sound. 45° bearing edges provide superbly articulate sensitivity.



### SR1000

SR1000 Glide-Lock Strainer's locking throw off lever and tension knob assures slip-free performance. (U.S. Patent #7220905, #7301087, #7365256)

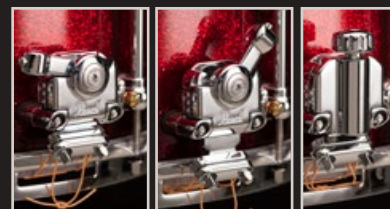

### OPTIMOUNT

Aluminum Tom Mounts suspend the drum evenly across four tension points to allow resistance-free resonance in play.



### AIR SUSPENSION RUBBER TIP

(U.S. Patent #5881981) isolates the tom from the floor, preventing tonal choke and increasing resonance.



### GOLDEN RATIO AIR VENT

(U.S. Patent #7485791) is precision placed on toms to increase low-end response, while low-contact floor tom brackets increase sustain.





## MUSIC CITY CUSTOM

*Hand-Assembled in the USA for  
True Pearl Artists... Like You.*



### A FOUR DECADE TRADITION OF ARTIST CRAFTSMANSHIP

For over 40 years, our exclusive USA Artist Custom shop has collaborated with some of drumming's most illustrious names to handcraft their personal touring kits. Pearl now invites you to experience the same level of unparalleled service with the Music City Custom Program.

Music City Custom drums feature pristine shells of the finest wood plies, manufactured in Pearl's renowned overseas Masterworks facility.

Choose from the tonal complexity of Reference or Reference Pure blended shells, or the sonically-centered 4-ply MRV shell formula.

All shells are precision CNC drilled and hand-assembled at our USA Custom Shop in Nashville, TN, in a choice of 46 drum sizes and 36 beautiful covered finishes.

Experience what our top endorsees have enjoyed for years with Music City Custom.

### REFERENCE

Created to draw the best sonic properties from each drum for optimum tone and playability by size and application.

#427 BRIGHT CHAMPAGNE SPARKLE





# MUSIC CITY CUSTOM

*Music City Custom:  
REFERENCE PURE*



**GET IT WHEN  
YOU NEED IT.**

Our goal is to complete each Music City Custom kit within 14 business days from the date we receive your order through one of our many authorized dealers. Quick custom manufacturing, massive size and finish selection, industry leading craftsmanship, and Pearl's exclusive Lifetime Warranty all combine to set a new standard for USA born, high end drum sets.



Barry Kerch (Shinedown) and Dustin Steinke (SIXX:A.M.) backstage with their MCC kits.



Casey Cooper (YouTube: COOP3RDRUMM3R) with his MCC RFP kit in #416 Black N' White Oyster.

## REFERENCE PURE

The Reference Recipe in a thin shell/lightweight hardware combo for highly resonant response and shimmering tonality.



#416 BLACK N' WHITE OYSTER



# MUSIC CITY CUSTOM

*Music City Custom:*  
**MASTERS MAPLE RESERVE**



## ARTIST DESIGNED, HAND ASSEMBLED

From hand-covering every shell, to precision CNC drilling, hand-assembly and our painstaking final inspection process, Music City Custom provides the true artist experience and a drum set like no other.



## MASTERS MAPLE RESERVE

Pearl's classic MMP 4-ply shell with 4-ply re-rings, FatTone hoops, and CL bridge lugs for balanced Maple tone.

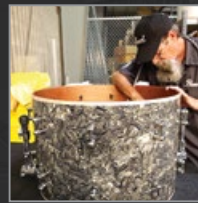

## HANDCRAFTED EXCELLENCE

Explore the option of three premium SST drum shell types; precision drilled to order, assembled, and immediately available in your choice of 36 tour ready finishes. From classic sparkles and vintage pearls to timeless favorites, it's here and ready to define your command of the stage.



## 36 IN-STOCK FINISHES

#403 RED ONYX	#405 NICOTINE WHITE MARINE PEARL (Large)	#407 RED GLASS	#409 DIAMOND GLITTER	#412 BLACK OYSTER GLITTER	#413 TURQUOISE GLASS
#414 ICE BLUE OYSTER	#415 BRONZE OYSTER	#416 BLACK N' WHITE OYSTER	#417 PEWTER ABALONE	#418 BLUE ABALONE	#419 BURNT ORANGE ABALONE
#420 GOLDEN YELLOW ABALONE	#421 BLACK DIAMOND PEARL	#422 MATTE WHITE MARINE PEARL	#423 VINTAGE GOLD SPARKLE	#424 VINTAGE BLUE SPARKLE	#425 CHARCOAL BLACK SPARKLE
#426 MIRROR CHROME	#427 BRIGHT CHAMPAGNE SPARKLE	#446 GREEN GLASS	#447 BURNT ORANGE GLASS	#448 WHITE MARINE PEARL (Large)	#449 CLASSIC SILVER SPARKLE
#451 MOLTEN SILVER PEARL	#452 PEARL WHITE OYSTER	#453 PLATINUM GOLD OYSTER	#495 CLASSIC BLACK OYSTER	#496 PLATINUM SMOKE MARINE	#720 CRANBERRY SATIN SWIRL
#721 BLUE SATIN MOIRE	#722 WHITE SATIN MOIRE	#723 GOLD SATIN MOIRE	#724 SHADOW GREY SATIN MOIRE	#725 SATIN GREY SEA GLASS	#763 MATTE BLACK OYSTER

To find out about this and other ICON RACK RECIPES, go to [www.pearlrackrecipes.com](http://www.pearlrackrecipes.com)

#451 MOLTEN SILVER PEARL



# MASTERS MAPLE RESERVE

*A Classic Formula  
For Sonic Greatness.*

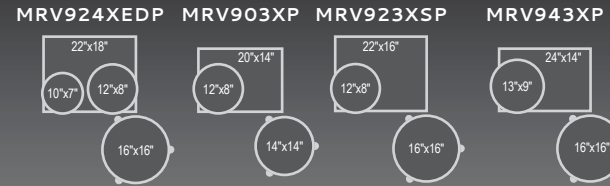

MRV923XSP/C  
#343 OLIVE BURST

## THE MASTERS LEGACY

Masters Maple Reserve drums deliver a balanced tonal combination of powerful midrange and smooth resonant shimmer. Featuring our original Masters Series shell formula, Pearl uses only premium North American Maple veneers from our Masterworks supply vault to give Masters Maple Reserve a sophisticated, vintage-flavor. All Masters drums feature Pearl's proprietary 38-step lacquering process, for refined looks and a singular, distinctive playing experience.

Shell: 4-ply (5mm) 100% Maple w/ 4-ply Maple Re-Rings  
 Snare: Matching 14x5.5 or 14x6.5 (Sold Separately)  
 Finish: Super High Gloss and Matte Lacquer  
 Heads: Remo Clear Ambassador Tom, Ported Powerstroke3 Bass  
 Tom Mounts: Aluminum OptiMount Suspension System  
 Drum Hardware: Chrome  
 Hoops: Low Mass FatTone Hoops  
 Lugs: CL Bridge Lugs  
 BD Muffler: BDMF (Full Size)



MRV903XP/N  
#353 MATTE WHITE



### SHELL

4-ply Maple shell with 4-ply Maple Reinforcement Rings - A classic shell fusion delivering rich, sustained lows and controlled sonic punch.

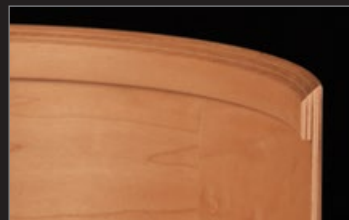

### HARDWARE

FatTone Hoops feature a rigid 1.6mm hemmed/welded edge that extends sustain and resonance without losing projection.



### STANDARD 45° BEARING EDGE

A precise low-contact edge that adds resonance to Maple's powerful midrange tone.

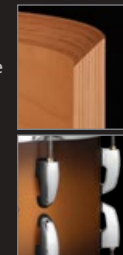

### CL BRIDGE LUGS

A classic look with minimal shell contact at separate points for precise vibration control.

### ALUMINUM OPTIMOUNT SUSPENSION SYSTEM

A light and efficient four-point drum mount that delivers secure tom suspension without penetrating the shell.





## MASTERS MAPLE GUM

*Limited Edition,  
Unlimited Sound.*

### THE MASTERWORKS STUDIO RECIPE, SIMPLIFIED.

Delivering arguably the greatest drum tones ever recorded, the historically proven sound of the Maple/Gum shell combination is renowned worldwide for its explosive midrange warmth and extended low end power.

Now, Pearl makes this coveted sound available with Masters Maple/Gum Series, the first limited production Masterworks kit we have ever made.

Offered in two preselected shell packs for the sound conscious professional player, each kit features a vault cured EvenPly-Six layered premium North American Maple and Gum wood shell with 60 degree edges, Mastercast Die-Cast hoops, and Pearl's CL bridge lugs.



Shell: EvenPly Six (6-ply, 5.4mm) North American Maple/Gum  
Finish: Hand-Rubbed Natural Wax or Premium USA Wrap  
Heads: Remo Coated Ambassador, Powerstroke3 Bass  
Tom Mounts: OptiMount Aluminum Suspension System  
Drum Hardware: Chrome  
Hoops: Mastercast Die-Cast  
Lugs: CL Bridge Lugs

MMG924XSP/C  
#453 PLATINUM GOLD OYSTER  
WITH ADDED 14"x14" FLOOR TOM (MMG1414F/C)



#### SHELL

EvenPly-6, 4-ply Maple outer with 2-ply Gumwood inside - Enhancing Maple's naturally resonant warmth, the Gum interior of this thin, powerful shell increases volume and adds control for pristine, articulate tone.



#### BEARING EDGE

Outer 60° - Featuring a shallow back cut to increase punch, this tried-and-true edge transfers natural control from the head to the shell.



#### HARDWARE

MasterCast Hoops - To increase total drum weight on this thin-shelled recipe, MasterCast Hoops increase volume and attack.



#### CL BRIDGE LUGS

Pearl began the low-contact lug phenomenon with this original Bridge-type design, for reduced surface-to-shell contact and boosted sustain. CL100 / 250

#### CONFIGURATIONS



#### FINISHES



#186 HAND RUBBED NATURAL MAPLE #421 BLACK DIAMOND PEARL #422 MATTE WHITE MARINE #453 PLATINUM GOLD OYSTER



# MASTERS MAPLE COMPLETE

*The Masters Shell Comes Full Circle.*

Shell: EvenPly Six (6-ply, 5.4mm) 100% Maple  
 Snare: Matching 14x5.5 or 14x6.5 (Sold Separately)  
 Finish: Matte Lacquer and Lacquer Sparkles  
 Heads: Remo UT Pinstripe Tom,  
 Ported UT Powerstroke3 Bass  
 Tom Mounts: OptiMount Suspension System  
 Drum Hardware: Chrome  
 Hoops: SuperHoop II (2.3mm Triple-Flanged)  
 Lugs: CL Bridge Lugs  
 BD Muffler: BDMM (Mini)



MCT923XSP/C  
#351 SATIN NATURAL BURST

## UNPARALLELED SOUND. ATTAINABLE PRICE.

Fully loaded with all the elements that made Pearl's Masters Series a must for the touring drummer, Masters Maple Complete offers a tonally superior percussive statement for the road ready pro.

Its thin EvenPly-Six Maple shell reacts with driving presence, commanding your groove with powerful punch and increased low-end sustain.

Showcasing a host of premium appointments including the OptiMount Tom Suspension System and insulated die-cast bass drum claw hooks, Masters Maple Complete raises the bar for the drummer that expects nothing but the best from the Masters name.



MCT924XEDP/C  
#346 VERMILLION SPARKLE



MCT903XP/C  
#347 BOMBAY GOLD SPARKLE



Six premium lacquer finishes are available in four preconfigured shell packs, as well as a host of component and add-on drums.

MCT924XEDP/C MCT903XP/C MCT923XSP/C MCT943XP/C

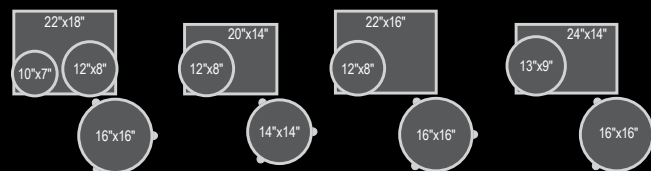

### SHELL

EvenPly-Six (5.4mm) North American Maple - Fuses reduced thickness, cross laminated ply panels for expanded tonal purity and increased resonance.



### BEARING EDGE

Standard 45° - Pearl's original precision edge adds sustain through reduced shell-to-head contact.



### HARDWARE

2.3mm Superhoop II Hoops - Made to maintain tuning integrity in heavy play while delivering maximum shell resonance.



### CL BRIDGE LUGS

A classic look with minimal shell contact at separate points for precise vibration control.





## SESSION STUDIO SELECT

*A Completely New Take on the Full Spectrum Sound.*

**A TRUE PEARL ORIGINAL, WITH A FRESH, GROOVE INSPIRING VIBE.**

Taking a tip from the Masterworks spectrum, Session Studio Select's upgraded combination of Masters-grade Birch and African Mahogany deliver a truly refined standout in the drumming world. A sonic dichotomy of smooth low end and piercing projection, its sophisticated look and feel make it the prime choice for the evolving modern drummer.

Pearl's Session sound originated over a quarter century ago in a punchy, vibrant shell hybrid of Birch and Mahogany. Its stunning harmonic variety made it a must for both live and studio drummers.



STS925XSP/C  
#315 ANTIQUE CRIMSON BURST



STS925XSP/C  
WITH ADDED 8"x7" TOM (STS0807T/C) AND KMI BOP PAD  
#766 BLACK MIRROR CHROME

To find out about adapting ICON Accessories to your setup, go to [www.pearltrackrecipes.com](http://www.pearltrackrecipes.com)

HIGH GLOSS LACQUER

#314 GLOSS BARNWOOD BROWN	#315 ANTIQUE CRIMSON BURST	#316 BLACK HALO GLITTER

PREMIUM DELMAR WRAP

#405 NICOTINE WHITE MARINE PEARL	#414 ICE BLUE OYSTER	#766 BLACK MIRROR CHROME



### SHELL

EvenPly-Six Birch/African Mahogany. A unique thin-shell combination of the dense, pre-EQ'd punch of Premium Birch cross-laminated with the dark tone of African Mahogany.



### BEARING EDGE

Outer 60-Degree. Increases volume and punch without harsh overtones.



### HARDWARE

SuperHoop II, 2.3mm Triple-Flanged hoops for rigid tuning stability without robbing the shell of sustain.

### PROFESSIONAL SOUND. CLASSIC VALUE.

STS carries on the Session tradition of value for the drummer with three specially priced 4-pc. shell sets, each including a FREE added floor tom.

#### STS925XSP/C

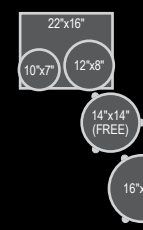

#### STS944XP/C



#### STS905XP/C

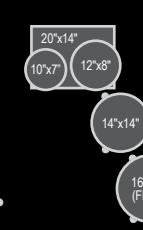

Shell: EvenPly Six (6-ply, 5.4mm) Birch/African Mahogany  
Snare: 14x5.5, 14x6.5, or 14x8 Matching\* Wood  
Finish: Premium Wrapped or High Gloss Lacquer  
Heads: Remo Pinstripe Clear Tom, Powerstroke3 Bass, UT Coated Snare  
Tom Mounts: OptiMount Suspension System  
Tom Arms: Sold Separately  
Drum Hardware: Chrome  
Hoops: Superhoop II 2.3mm Triple Flanged  
Lugs: RL Lugs *\*Sold Separately*



# CRYSTAL BEAT

The Original Seamless Acrylic Drum Set.



**CRB525FP/C**  
#731 RUBY RED  
WITH ADDED 22"X16" BASS DRUM (CRB2216BX/C) AND ADDED ROCKET TOMS IN #730 ULTRA CLEAR

To find out about this and other ICON RACK RECIPES, go to [www.pearlrackrecipes.com](http://www.pearlrackrecipes.com)



Originating in 1973, Pearl's Crystal Beat Acrylic drums feature a 7mm molded/seamless Acrylic shell for a vivid combination of cutting tonal power and stunning visual appeal.



**CRB543P/C**  
#732 TANGERINE GLASS



**CRB525FP/C**  
#733 FROST ACRYLIC

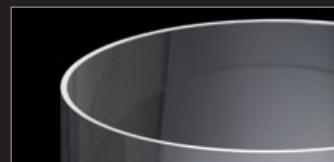

**SEAMLESS ACRYLIC SHELL** features a dual 45° bearing edge with a rounded apex, adding control and increased articulation to acrylic's sonic signature.



**TOMS** include the OptiMount suspension system for increased sustain and 1.6mm triple-flanged hoops for attack and punchy tonal body.

Shell: 7mm Seamless Molded Acrylic  
Snare: Matching Free Floater (Sold Separately)  
Finish: Transparent  
Heads: 2-Ply on Tom Batters, Single-Ply Resonant  
Tom Mounts: OptiMount Suspension System  
Tom Arms: Sold Separately  
Drum Hardware: Chrome  
Hoops: 1.6mm Triple-Flanged  
Lugs: CB Mid-Lugs on Toms, CB Fat-Lugs on Bass

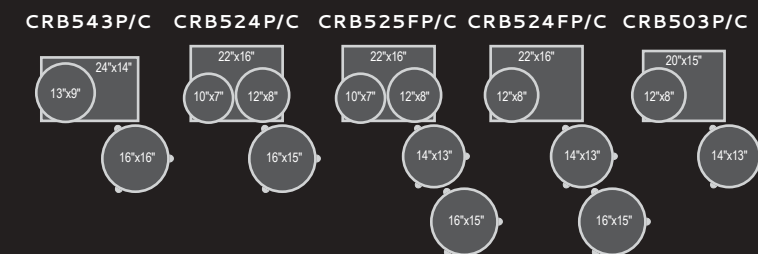

Crystal Beat's strong percussive assault is available in a choice of four image enhancing colors, a host of sizes and setups, and even single headed and Rocket tom options for a clearly striking drum statement.



#730 ULTRA CLEAR #731 RUBY RED #732 TANGERINE GLASS #733 FROST ACRYLIC



## DECADE MAPLE

*A Drum Kit 10 Years in the Making.*

### PRACTICE TIME IS OVER, IT'S TIME TO GET SERIOUS.

Backed by the industry's only Lifetime Guarantee, Decade Series drums elevate the playing field for the advancing drummer with feature heavy, lacquered Maple shells at an unbeatable value. Built to push the boundaries of performance and price, Decade Maple drums are perfect as a primary kit for evolving players, or a secondary "gigging" kit for the seasoned pro.



Shell: Even Ply 6 (5.4mm) 100% Maple  
 Snare: 14 x 5.5 Matching  
 Finish: High-Gloss / Matte Lacquer  
 Heads: Remo UT Clear Ambassador Tom, Ported UT Powerstroke3 Bass  
 Tom Mounts: Opti-Loc Mounting System  
 Drum Hardware: Chrome  
 Hoops: 1.6mm Steel Triple Flanged  
 Lugs: NDL Lugs  
 BD Muffler: BDMM (Mini)



DMP925SP/C  
 #221 FADED GLORY



DMP943XP/C225  
 #225 CLASSIC SATIN AMBURST

DMP927SP/C  
 #229 WHITE SATIN PEARL  
 with 20" Gong Drum on two ICON straight racks

For a complete listing of ICON Drum Racks and Parts, see Pages 64-66

CULTURED LACQUER FINISHES Available in an array of choices to give each shell exterior a spectacularly vibrant look.

### THE DECADE DIFFERENCE



#### SHELL

6-ply/5.4mm Maple - Thin (but powerfully strong) Pearl's SST shell reacts quickly to the stroke with beautifully resonant highs and thundering lows.



#### OPTI-LOC MOUNTING SYSTEM

This three-point isolation mount suspends the drum at two tuning points and one of the drum's air vents for solid, stable play.



#### HARDWARE

Features include Uni-Lock gearless tom arms, insulated die-cast claw hooks, R40 Air Suspension Floor Tom feet, bass drum muffling cushion, and Decade mini lugs for reliable, rock solid durability and sound.

DMP905P/C

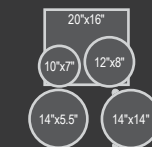

DMP925SP/C

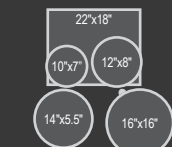

DMP943XP/C

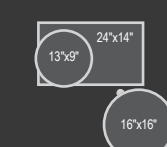

DMP927SP/C

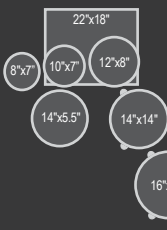

\*#234 only available in DMP925SP/C configuration



## EXPORT LACQUER

*The Legends Of Tomorrow, Play Export Today.*

After 30 years of being the #1 Selling drum set in the world, Export Series is still the name every drummer knows. Having jump started thousands of drumming careers by bringing quality and value into one package, today's Export continues to build legends.

With features like Reference-inspired shell composition, a choice of wrap (EXX) or high-gloss lacquer (EXL) finish, and our unbeatable 830 Series hardware package, Export is ready to fuel the fire for future drumming icons.

Shell: 6 Ply 7.5mm Poplar & Asian Mahogany Blend  
 Snare: 14 x 5.5 Matching Wood Snare  
 Finish: Choice of 5 High Gloss Lacquer Finishes  
 Heads: Remo Clear Tom Head, Powerstroke Bass Head  
 Tom Mounts: Opti-Loc Mounting System  
 Tom Arms: TH70I  
 Drum Hardware: Chrome  
 Hardware: P930, BC830, C830, H830, S830

Shell: 6 Ply 7.5mm Poplar & Asian Mahogany Blend  
 Snare: 14 x 5.5 Matching Wood Snare  
 Finish: Choice of 7 Covered Finishes  
 Heads: Remo Clear Tom Head, Powerstroke Bass Head  
 Tom Mounts: Opti-Loc Mounting System  
 Tom Arms: TH70I  
 Drum Hardware: Chrome  
 Hardware: P930, BC830, C830, H830, S830

## EXPORT

*The Best Selling Drum Set of All Time.*

Export Series incorporates Pearl's SST (Superior Shell Technology), Opti-Loc Mounting System, 830 Series Hardware with a P930 Pedal, and a choice of seven amazing stocking finishes.

### SHELL

6-ply/7.5mm Poplar/Asian Mahogany. A Pearl SST (Superior Shell Technology) blend for high volume resonance and sustained low-end wallop.



EXL725S/C  
#220 SATIN BROWN



EXX725S/C  
#760 BURGUNDY WITH DOUBLE BASS  
ADD-ON PACK (EXX22P/C)

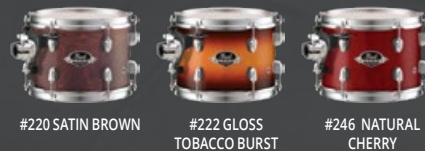

#220 SATIN BROWN

#222 GLOSS TOBACCO BURST

#246 NATURAL CHERRY

#248 BLACK SMOKE

#249 HONEY AMBER



#21 SMOKEY CHROME

#31 JET BLACK

#33 PURE WHITE

#49 MIRROR CHROME

#708 GRINDSTONE SPARKLE

#717 HIGH VOLTAGE BLUE

#760 BURGUNDY

### THE BEST SELLING DRUM SET OF ALL TIME.

Crafted to capture the look, sound, and feel of top end gear at an accessible price, Export Lacquer drums boast a list of features that is far beyond their low price tag. Everything you would expect from the #1 selling drum set in the world is

upgraded and ready to fuel the fire of drumming for the serious player.

Available in three configurations in a choice of five lacquered finishes, Export Lacquer can be expanded with a wide range of matching add-on components to create a setup as unique as your playing signature.

### CONFIGURATIONS Includes HWP830 Hardware

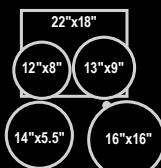

EXX725/C  
EXL725/C

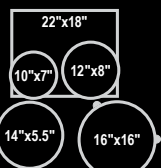

EXX725S/C  
EXL725S/C

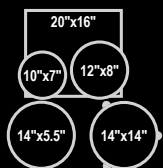

EXX705N/C  
EXL705N/C

### 830 SERIES HARDWARE

Sophisticated, sturdy, and efficient, Export's 830 Series Boom (BC830), Cymbal (C830), and Snare (S830) stands all feature gearless Uni-Lock Tilters for pinpoint positioning, and robust double-braced tripods for secure stability in play. The H830 Hi-Hat stand also features swivel legs that accommodate double pedals.



P930  
DRUM PEDAL

### P930 PEDAL

Featuring the longboard styling and feel of Pearl's Demon Drive pedal, the P930 offers two chain drive cam options for power, speed, and control.

### OPTI-LOC MOUNTING SYSTEM

Pearl's three way tom mount delivers wobble free stability by suspending the drum at two tuning points and one of the drum's two air vents.





## MIDTOWN

*Big Gig, Small Rig, Huge Sound.*



Lift used on Midtown raises the drum to the optimal position for your pedal.



MDT764P/C  
#701 BLACK GOLD SPARKLE

### SETTING THE PULSE FOR THE METROPOLITAN GROOVE

Matching the vibe and pace of the modern city drummer, Pearl's ultra-portable Midtown Kit is a vital sounding board for sculpting rich, powerful beats. With full-size sound and play in a smaller footprint, Midtown's elevated 16" kick drum and tight tom and snare package flow from the street to the stage with ease; perfect for the gigging drummer on the move.



#701 BLACK GOLD SPARKLE



#704 BLACK CHERRY GLITTER

### INSTANTLY PORTABLE

Price conscious and ideal for tight spaces, the Midtown Kit's compact size quickly breaks down into two optional gig bags (PMTBG) for quick transport.

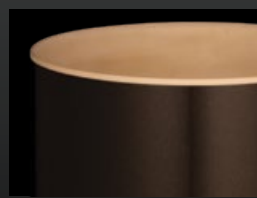

6 Ply 7.5 mm Poplar

Shell: 6 Ply 7.5 mm Poplar  
Snare: 13 x 5.5 Matching Wood Snare  
Finish: Choice of 2 Covered Finishes  
Heads: Remo Clear Toms, Powerstroke Bass, Clear Batter Coated Front  
Tom Arms: TH701  
Hardware: Chrome

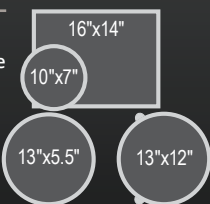

### COMPACT TRAVELER

Pearl's Compact Traveler includes a slim 18" bass drum and 10" snare mounted off a 3/8" post. An expansion pack including 10" and 14" toms and mounting hardware is also available. Optional bags make transporting your Compact Traveler very easy.



PCTK1810  
shown with PCTKT1014 add on pack  
HW/Cymbals sold separately



PCTK1810  
Pedal sold separately

PCTKT1014  
Add on pack (10" & 14" toms  
w/mounting hardware)

PSCPCTK  
Optional Compact Traveler Bag

PSCPCTKADD  
Optional Compact Traveler Add on Bag

Shell: 9 Ply 7mm Asian White Poplar  
Snare: Matching Wood Snare  
Finish: Choice of 5 Covered Finishes  
Heads: Clear Tom Heads, Coated Snare Head, Self-Muffled Bass Head  
Tom Arms: Individually Locking 7/8" Tube Joint Holders  
Hardware: Dual-Chain Drive Bass Drum Pedal, Double-Braced Cymbal\*, Snare, and Hi-Hat Stands, Double-Braced Throne  
Cymbals: 16" Brass Cymbal, 14" Brass/Hybrid Hi-Hat Cymbals  
Accessories: Pro Drum Stick Bag, Two pair of Maple 5A Sticks  
\*Docking Cymbal Boom Arm Included with RS584C/C

### THE RHYTHM IS IN YOU

Drumming knows no age limit. Regardless of when your rhythmic journey starts, Pearl's Roadshow Series has a drum set package scaled for players of all ages that includes everything you need to get on the road to drumming greatness.



BASS DRUM PEDAL

THRONE INCLUDED

### STANDARD CONFIGURATIONS

Complete Sets with Hardware, Cymbals, and Throne.



RS525SC/C  
#91 RED WINE

RS525WFC/C  
#31 JET BLACK

RS505C/C  
#707 BRONZE METALLIC

RS584C/C  
#706 CHARCOAL METALLIC



## ROADSHOW

*It's Your Time to Play, Start the Right Way!*



RS525SC/C  
#703 AQUA BLUE GLITTER

THE HEART OF THE ROADSHOW SOUND. Roadshow is crafted to be everything you'd expect from a Pearl Drum set, featuring a 9 ply Poplar shell for optimum tonal power.



#31 JET BLACK

#91 RED WINE

#703 AQUA BLUE GLITTER

#706 CHARCOAL METALLIC

#707 BRONZE METALLIC



NATE MORTON  
THE VOICE

For additional info, testimonials, free assembly and instructional videos, and access to the largest drummer's community on the web, go to:

[WWW.MYFIRSTDRUMSET.COM](http://WWW.MYFIRSTDRUMSET.COM)

### ROADSHOW JR.

Following in the footsteps of Pearl's Roadshow series for beginning drummers, this is not merely a toy made to look like a drum set. The Roadshow Jr. is an all-in-one five piece kit featuring hardware, cymbals, and sturdy White Poplar shell construction for an exceptional, tuneable, powerful playing experience.



RSJ465/C

#31 JET BLACK

#708 GRINDSTONE SPARKLE

RSJ465/C  
#31 JET BLACK

RSJ465/C  
#708 GRINDSTONE SPARKLE





# e/MERGE

Powered by KORG.



INTRODUCING  
**e/MERGE**  
Not Just a New Standard.  
A new sound. A new feel. And, a completely new e-drumming experience.

**e/MERGE** is about change, and change in the e-drum market has been way overdue. When we looked closely at every aspect of the current e-drumming experience with KORG, together we knew we could make a dramatic difference. And that difference begins with the all new e/MERGE module. Simple yet elegant in design, the e/MERGE MDL-1 module features a full library of high definition, natural, organic and minimally processed acoustic Pearl drums. We then added the very best electronic, world, orchestral and specialty percussion sounds from KORG's vast library of pristine quality samples. But, the module is only part of the change.

**Introducing WAVE TRIGGER TECHNOLOGY**  
This all new technology partially based upon KORG's now legendary Wave Drum brings a realism, instantaneous response and dynamic range never before imagined possible. The sensitivity provided by WTT is simply amazing. Pearl's all new PUREtouch Pad System completes the experience. PUREtouch has been painstakingly developed to create a true acoustic-like pad experience. No excessive unnatural bounce and no wrist shaking ultra-hard practice pad like feel, PUREtouch provides the sizes and feel every acoustic drummer has come to expect.

MODULE SPECIFICATIONS

SOUND GENERATOR	2 CPU (4 core + 2 core)	DISPLAY	3.25" x 1" Graphic LCD
POLYPHONY	128 Voices	CONNECTORS	Master Out L/Mono & R
VOICE	700 HD Sound Library		Direct Out (8)
DRUM KIT	35 HD Kits		Headphones Out
EFFECTS	36		Aux In TRS Mini
SONG RECORDING TYPE	44.1kHz, 16 Bit WAV		Main Trigger inputs (DB-25 Connector)
SONG RECORDING TIME	Approximately 12 Hours		Accessory Inputs (3)
CLICK TEMPO	BPM 30 - 300		USB to PC Port (Transport USB Audio & MIDI Data)
BEAT	1/2 - 24/2, 1/4 - 24/4, 1/8 - 24/8, 1 - 24/8T, 1/16 - 24/16 (T=Triplet)		USB-A (for WAV files and Settings Data)
CLICK VOICES	10	MIDI	MIDI Output
CONTROLLERS	Knobs and Ambient Slider Control	POWER SUPPLY	100-120V, 50-60Hz, Switching Power Supply
		DIMENSIONS, WEIGHT	2.2lbs, 9"W x 7.5"D x 2"H

There are three key elements that separate **e/MERGE** from anything that has come before. The all new MDL1 e/MERGE Module, KORG's amazing WAVE TRIGGER TECHNOLOGY and Pearl's acoustic-like PUREtouch electronic pads and cymbals combine to create an exceptional e-drumming experience.



**e/MERGE MDL1 MODULE**  
Simple, straight forward yet extremely powerful, the MDL-1 module offers, a pair of powerful multicore processors, a full library of acoustic Pearl drums recorded in one of the world's most renowned studios, pristine samples from KORG's library and the variety of routing options every e-drummer needs.

**PUREtouch PADS & CYMBALS**   
Perfectly sized pads designed to replicate the ultimate acoustic-like response. PUREtouch features layer upon layer of specially designed materials each selected for a specific quality that together create an e-experience never before possible.



Each e/MERGE kit includes a PUREtouch Electronic Cymbal pack consisting of an 18" three zone Ride (bell, bow and edge), 15" two zone Crash (bow and edge), and 14" two zone Hi-hats (bow and edge). PUREtouch Crash and Ride Cymbals feature a multilayer construction encapsulated in rubber with a playing action similar to that of acoustic cymbals, but with a slightly softer feel for controlled sound volume.



**WAVE TRIGGER TECHNOLOGY**  
This ultra-fast and highly sensitive technology partially based upon KORG's groundbreaking Wave Drum allows even your stick choice to make a discernible difference in the sound of your drum.



WTT is fast. As fast as audio. Faster than anything simply trigger based. This speed adds a realism to the playing experience never before available to the e-drummer. WAVE TRIGGER TECHNOLOGY uses parallel processing of your character and your sound and seamlessly layers it with high definition samples of real Pearl acoustic drums to create an end result that is as much a reflection of you as with any acoustic performance. With WTT, sample layers are smoothed, latency is imperceivable, and sensitivity is on a different dimension from anything that has come before.



**EM53HB**  
e/HYBRID CONFIGURATION  
10", 12" and 14" toms, a 14" snare, and 18" acoustic bass drum. PUREtouch Cymbals, ICON e-Rack, MDL1 Module.

The foundation of the e/MERGE electronic drum set is a custom designed, chrome plated ICON e-Rack system.

**EM53T**  
e/TRADITIONAL CONFIGURATION  
10", 12" and 14" toms, a 14" snare, and PUREtouch Kick Pad. PUREtouch Cymbals, ICON e-Rack, MDL1 Module.



## MIMIC PRO

Powered by Slate.

Download MIMIC PRO Software  
Updates and User Manual at  
[pearl-electronics-support.com](http://pearl-electronics-support.com)mimic PRO  
POWERED BY SLATE

MIMP24B

THE MOST AMAZING DRUM  
MODULE THE WORLD HAS  
EVER KNOWN.

## SERIOUSLY, IT'S THAT GOOD.

Superior sound, accurate triggering and connectivity are the most important features of a drum module. Pearl Drums and Steven Slate have joined forces to create "Mimic Pro" - the world's most advanced percussion sound source for studio and live performance applications.

At the heart of this ground breaking unit is the new Steven Slate 5 drum library that features multi-channel drum samples recorded in world class studios. Each instrument supports adjustment of Attack, Sustain, Release, Tune, Pan and volume. Instead of substituting digital effects to create ambience, these instruments use the actual ambient recordings with separate adjustment of close, overhead and room mics.

Mimic Pro is the first drum module to implement a 7" IPS touch screen and the first to offer 2 mixers for independent headphone and front house outputs. Now that the drummer is responsible for triggering loops and other sounds for a performance, Mimic Pro can import audio files to trigger from your pads.



## STATE OF THE ART FEATURES:

- 7" IPS Touch Screen with Programmable Data Wheel
- 120 gig solid state drive
- 16 Dual Zone Inputs
- 16 Programmable Audio Outputs
- Midi In and Out
- High Quality Digital to Analog Converters
- Two completely separate mixers for headphone and Main outs. (Drummer gets a personal mix with and without effects independent of Main outputs)
- Import Wave, Aiff or MP3 sound files
- Compatible with most pads on the market
- Steven Slate Drums 5 Library
- 24 bit multi channel sample library with separate adjustment of Close, Overhead and Room mics.
- Onboard effects include EQ, Compression, Reverb with Room Sizes
- Individual Cymbal Volume Adjustments for Bell, Bow, Edge, Chik and Splash
- All AUX and Cymbal inputs have choke function.
- Supports triple and dual zone cymbals and dual zone hi hat.
- SD card slot and USB.
- Additional Instruments and Libraries will be available
- Stereo Aux In and Onboard Metronome
- Internal Recording for Loops and/or Performances



Storage is no longer a problem with Mimic's 120GB Solid State Drive and lightning fast loading time. Speaking of connectivity, Mimic Pro is compatible with Pearl TruTrac pads and a host of pads from other manufacturers. Top

that off with sixteen audio outs, 16 Trigger inputs, independent SD card Slot, USB and Midi In & Out, Stereo Aux input and you would be hard pressed to find a better option for today's musician.

## malletSTATION™

## malletSTATION

The World's First 3.0 Octave Adjustable  
Range Electronic Mallet Controller.**PLAY** ANY  
INSTRUMENT THROUGH  
ANY DEVICE. ANY RANGE,  
ANYWHERE, ANYTIME.

The World's First 3.0 Octave  
Adjustable Range Electronic  
Mallet Controller. Powered By  
Cutting Edge Technology from  
Keith McMillen Instruments.

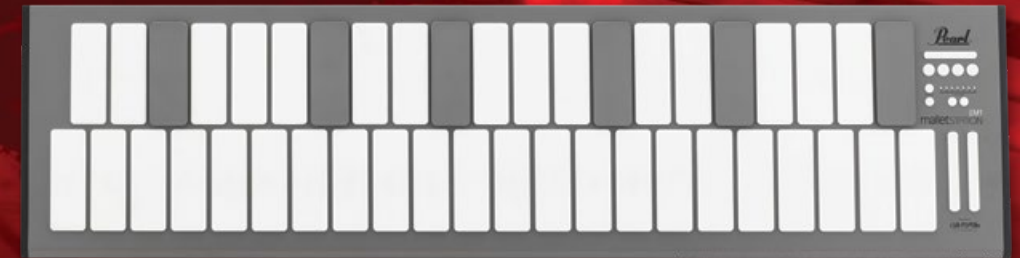

Pearl introduces the ultimate mallet keyboard controller for teachers, players,  
students, and professionals. Practice, perform, compose anywhere.

EM1

- 43, 1.75" x 5" soft silicone keys • 3 faders and 4 buttons, MIDI assignable • 3 MIDI assignable ¼" pedal inputs
- Bottom Note Range Shift up/down buttons • Octave up/down buttons • 1.6" H x 12.6" W x 49" L • 22.5 lbs

Pearl once again redefines the electronic percussion experience by introducing the revolutionary EM1 malletSTATION adjustable range electronic mallet controller.

The EM1 malletSTATION is a 3.0 octave adjustable range electronic mallet controller designed for all levels of player, from the beginning student through the gigging professional. The adjustable range function allows you to set the fundamental diatonic note of the instrument to what you need—low D xylophone? No problem! Powered exclusively by USB Bus Power, the malletSTATION is designed to be used with

Mac, PC, iPad, iPhone, and Android devices, making it the first truly portable mallet percussion controller on the market.

Designed in collaboration with Keith McMillen Instruments, malletSTATION's tech-forward design features KMI's Smart Fabric Sensor technology allowing the silicone bar material to have an extremely sensitive, natural response, including mallet dampening and aftertouch control, and all can be easily tailored to your individual playing style. The EM1 features a master control section, with 3 programmable faders, 4 programmable buttons, and the fixed function low note

and octave shift buttons. In addition, three assignable pedal inputs allow for flexibility in performance such as sustain, expression, or any MIDI parameter of your choice. These controls are fully programmable through a software editor so changing your configuration is as easy as clicking a mouse.

This is the controller that will grow with you throughout your playing career—from music apps on your phone or tablet, to professional digital audio workstations and sound libraries—your sounds and even the instruments you play are only limited by the software you run.

- USB Powered MIDI Mallet Keyboard Controller
- Universal Compatibility through phone/tablet/laptop
- Tech-Forward Design featuring KMI Smart Fabric Sensors
- Low Note, Adjustable, User defined 3.0 Octave Range
- Customizable mallet dampening and aftertouch modes for realistic performance techniques
- Natural feeling soft silicone keys, all-weather playing surface
- Assignable buttons and faders for customized control and functions
- Three assignable pedal inputs for expression and sustain
- Hybrid Aluminum and Steel Chassis design for durability and stability
- Optional MIDI Expander to use external MIDI Hardware (sold separately)
- Flexible mounting on desktop, X-stand, or module mounts (sold separately)
- Mounting plates, stands, cases, covers, and other peripherals (available separately)

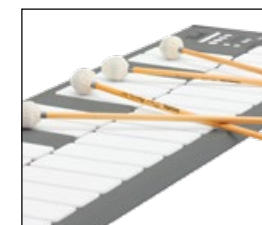
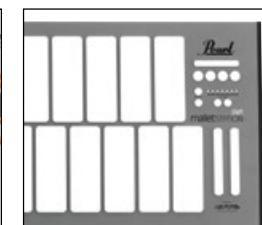
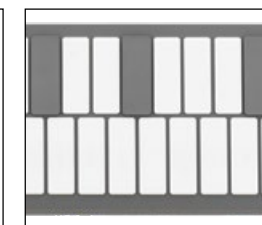

Shown Mounted on Vibraphone with Field Frame

1.75" x 5" Soft Silicone Keys  
powered by KMI Smart Fabric  
Sensor TechnologySoftware Assignable Control  
Panel with 3 Faders, 4 Buttons,  
plus Low Note and Octave ShiftMoveable Accidental "Gap  
Caps" for visual cues when low  
note range is adjustedJack panel with USB MIDI, MIDI  
expander port, and 3 MIDI  
assignable ¼" pedal inputsOptional Dual Module  
Mounts allow malletSTATION  
to easily mount on racks,  
stands, and field framesSleek, modern design with an  
ultra thin 1.6" profile



## REFERENCE SNARES

*The Ultimate Stable of Snares.*



All Reference snare drums feature Pearl's SR1000 Glide-Lock Strainer, which includes a locking throw off lever and tension knob that won't loosen no matter how hard you play. Low-friction technology permits smooth gliding action for ultra quiet, super precise motion. U.S. Patent #7220905, #7301087, #7365256



### RF1450S/C 14" x 5.5"

Shell: 20 ply (25mm): Maple 14 + Birch 6  
Hoops: MasterCast (DC1410/1410S)  
Lugs: BRL55  
Tension Rods: SST5047 Stainless Steel  
Strainer: SR1000 Glide-Lock Strainer  
Snares: SN1420D Ultra Sound "D" type



RF1450S/C



RFP1450S/C

### RFP1450S/C 14" x 5.5"

Shell: 6 ply (5.4 mm): Maple 4 + Birch 2  
Hoops: FatTone Hoops (FH1410/1410S)  
Lugs: STL55L  
Tension Rods: SST5047 Stainless Steel  
Strainer: SR1000 Glide-Lock Strainer  
Snares: SN1420D Ultra-Sound "D" type

### RF1465S/B 14" x 6.5"

Shell: 20 ply (25mm): Maple 14 + Birch 6  
Hoops: MasterCast (DC1410/1410S)  
Lugs: BRL65  
Tension Rods: SST5047 Stainless Steel  
Strainer: SR1000 Glide-Lock Strainer  
Snares: SN1420D Ultra Sound "D" type



RF1465S/B



RFP1465S/C

### RFP1465S/C 14" x 6.5"

Shell: 6 ply (5.4 mm): Maple 4 + Birch 2  
Hoops: FatTone (FH1410/1410S)  
Lugs: STL65  
Tension Rods: SST5047 Stainless Steel  
Strainer: SR1000 Glide-Lock Strainer  
Snares: SN1420D Ultra-Sound "D" type



RF1365S/C



RFP1365S/C

### RF1365S/C 13" x 6.5"

Shell: 20 ply (25mm): Maple 14 + Birch 6  
Hoops: MasterCast (DC1308/1308S)  
Lugs: BRL (8)  
Tension Rods: SST5047 Stainless Steel  
Strainer: SR1000 Glide-Lock Strainer  
Snares: SSN1320D Ultra Sound "D" type

### RFP1365S/C 13" x 6.5"

Shell: 6 ply (5.4 mm): Maple 4 + Birch 2  
Hoops: FatTone Hoops (FH1308/1308S)  
Lugs: STL65  
Tension Rods: SST5047 Stainless Steel  
Strainer: SR1000 Glide-Lock Strainer  
Snares: SN1320D Ultra-Sound "D" type



RFB1450



RFB1465

### RFB1450 14" x 5"

Shell: 3mm Brass  
Hoops: MasterCast (DC1410/1410S)  
Lugs: BRL55  
Tension Rods: SST5047 Stainless Steel  
Strainer: SR1000 Glide-Lock Strainer  
Snares: SN1420D Ultra Sound "D" type

### RFB1465 14" x 6.5"

Shell: 3mm Brass  
Hoops: FatTone Hoops (FH1410/1410S)  
Lugs: STL55L  
Tension Rods: SST5042 Stainless Steel  
Strainer: SR1000 Glide-Lock Strainer  
Snares: SN1420D Ultra-Sound "D" type



RFS1450



RFS1465

### RF1450S/C 14" x 5.5"

Shell: 2.5mm Cast Steel / 2.5mm R-Ring  
Hoops: MasterCast (DC1410/1410S)  
Lugs: BRL55  
Tension Rods: SST5047 Stainless Steel  
Strainer: SR1000 Glide-Lock Strainer  
Snares: SN1420D Ultra-Sound "D" type

### RFP1450S/C 14" x 5.5"

Shell: 2.5mm Cast Steel / 2.5mm R-Ring  
Hoops: MasterCast (DC1410/1410S)  
Lugs: BRL65  
Tension Rods: SST5047 Stainless Steel  
Strainer: SR1000 Glide-Lock Strainer  
Snares: SN1420D Ultra-Sound "D" type

## SERIES COMPONENT

*Masters, Session, and Decade Snares. Classic Pearl Sound.*

### MRV1455S/C 14" x 5.5"

Shell: 4 Ply Maple with 4 ply Maple R-Rings  
Hoops: FatTone (FH1410/1410S)  
Lugs: STL55  
Tension Rods: SST5055 Stainless Steel  
Strainer: SR017  
Snares: S022N



MRV1455S/C



MRV1465S/C

### MRV1465S/C 14" x 6.5"

Shell: 4 Ply Maple with 4 ply Maple R-Rings  
Hoops: FatTone (FH1410/1410S)  
Lugs: STL65  
Tension Rods: SST5047 Stainless Steel  
Strainer: SR017  
Snares: S022N

### MCT1455S/C 14" x 5.5"

Shell: 6 Ply Maple (5.4mm)  
Hoops: FatTone (FH1410/1410S)  
Lugs: STL55  
Tension Rods: SST5055 Stainless Steel  
Strainer: SR017  
Snares: S022N



MCT1455S/C



MCT1465S/C

### MCT1465S/C 14" x 6.5"

Shell: 6 Ply Maple (5.4mm)  
Hoops: SuperHoop II (SH1410B/1410S)  
Lugs: CL65  
Tension Rods: T061L  
Strainer: SR017  
Snares: S022N



STS1480S/C



STS1465S/C

### STS1480S/C 14" x 8"

Shell: 6-ply (5.4mm) Birch/African Mahogany  
Hoops: SuperHoop II (SH1410B/1410S)  
Lugs: CL100  
Tension Rods: T062  
Strainer: SR017  
Snares: S022N

### STS1465S/C 14" x 6.5"

Shell: 6-ply (5.4mm) Birch/African Mahogany  
Hoops: SuperHoop II (SH1410B/1410S)  
Lugs: CL65  
Tension Rods: T062  
Strainer: SR017  
Snares: S022N



STS1455S/C



DMP1455S/C

### STS1455S/C 14" x 5.5"

Shell: 6-ply (5.4mm) Birch/African Mahogany  
Hoops: SuperHoop II (SH1410B/1410S)  
Lugs: CL55  
Tension Rods: T062  
Strainer: SR017  
Snares: S022N

### DMP1455S 14" x 5.5"

Shell: 6 Ply (5.4mm) Maple  
Hoops: 1.6mm Steel (RH1408/1408S)  
Lugs: NDL55/C  
Tension Rods: SST5047  
Strainer: SR700  
Snares: SNW1420



## FREE FLOATING

### The Ultimate Purity of Sound.

Over 30 years ago, Pearl introduced the Free Floating Snare Drum. A milestone achievement in snare drum evolution, this unique system removes all hardware from the shell to greatly improve the drum's resonance and projection. Free Floating snare models are tailored to bring power, clarity, and true articulation to fit nearly any playing environment.

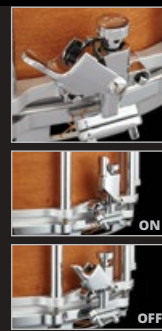

**TASK-SPECIFIC INNOVATION** Just as each player has an individual voice, snare drums speak differently depending on shell type, size, weight, and application. With the latest Free Floating snare models, Pearl's engineers crafted each to fit a specific task by model. By combining the tonal character of each shell type with its ideally-matched depth - and adding different Ultra-Sound snare wires to further sculpt individual tonal personality - these Task-Specific Free Floating snares give the player a unique voice for any sonic situation.

**CLICK-LOCK THROW-OFF SYSTEM** Featured on all new Free Floating snare models, the Click Lock Throw-Off is engineered with Polymer bearings for precise and smooth action. The unique nylon grip mechanism locks the snares into place at the top position, and disengages quickly when released.

#### FTAL1480 14" x 8"

Deep, rich snare power with short, even sustain decay.  
Shell: 1.2mm Seamless Aluminum  
Hoops: MasterCast (DC1410/DC1410S)  
Lugs: FT80  
Tension Rods: SST5042  
Strainer: SR160F  
Snares: SN1442C



FTAL1480



FTMH1480

#### FTMH1480 14" x 8"

Ultimate in throaty, deep snare growl. Shortened decay.  
Shell: 8 ply (10mm) African Mahogany  
Hoops: MasterCast (DC1410/DC1410S)  
Lugs: FT80  
Tension Rods: SST5042  
Strainer: SR160F  
Snares: SN1442C

#### FTPB1465 14" x 6.5"

Lower overtone body, preserves crisp top-end snare snap.  
Shell: 1.2mm Phosphor Bronze  
Hoops: MasterCast (DC1410/DC1410S)  
Lugs: FT65  
Tension Rods: SST5042  
Strainer: SR160F  
Snares: SN1420C



FTPB1465



\*4 ply Maple w/ 2 ply inner African Mahogany

FTMMH1465

#### FTMMH1465 14" x 6.5"

Full, rounded bottom frequencies. Extra midrange body.  
Shell: 6 ply (7.5mm)\*  
Hoops: MasterCast (DC1410/DC1410S)  
Lugs: FT65  
Tension Rods: SST5042  
Strainer: SR160F  
Snares: SN1420C

#### FTBR1450 14" x 5"

Full-spectrum, both bright in punch and warm in tone.  
Shell: 1mm Brass  
Hoops: MasterCast (DC1410/DC1410S)  
Lugs: FT50  
Tension Rods: SST5042  
Strainer: SR160F  
Snares: SN1420I



FTBR1450



FTMM1450

#### FTMM1450 14" x 5"

Punchy and smooth. A perfect "go-to" snare.  
Shell: 6 ply (7.5mm) Maple  
Hoops: MasterCast (DC1410/DC1410S)  
Lugs: FT50  
Tension Rods: SST5042  
Strainer: SR160F  
Snares: SN1420I

#### FTSS1435 14" x 3.5"

1mm shell for bright, open attack with ringy overtone.  
Shell: 1mm Stainless Steel  
Hoops: MasterCast (DC1410/DC1410S)  
Lugs: FT35  
Tension Rods: SST5035  
Strainer: SR160F  
Snares: SN1420D



FTSS1435



FTBB1435

#### FTBB1435 14" x 3.5"

Dense all Birch shell delivers bright, open attack.  
Shell: 6 ply (5.4mm) Birch  
Hoops: MasterCast (DC1410/DC1410S)  
Lugs: FT35  
Tension Rods: SST5035  
Strainer: SR160F  
Snares: SN1420D



**INTRODUCING VECTORCAST™** A single tiny strand can make all the difference in the world. Beginning with a composite material filament and resin thread, Pearl's new VectorCast shell is formed around a mandrel in an X-pattern; creating a thin, high-strength shell that "flexes" with each strike. Its characteristic sound is both lively and fat, and is a vast departure from other synthetics like Acrylic or Carbon Fiber.



K180 TUNING KEY

**SPIN-TIGHT™ TENSION RODS** To maintain tuning tension across the batter head, all Hybrid Exotic snare drums feature Pearl's Spin-Tight tension rods. This elegantly simple innovation creates a tension rod-within-a-tension rod, that allows the rod to expand and lock into place within the swivel nut. Utilizing a special drum key, tunings can be controlled under high-impact play like never before. (Patent Pending)



HEK1450



HEK1465



HEAL1450



HEAL1465



HEP1450



HEP1465

## HYBRID EXOTIC

### Space-Age Precision, Timeless Tone.

**GLIDE-LOCK THROW-OFF SYSTEM** Pearl's SR1000 Glide-Lock Strainer's locking throw-off lever and tension knob assures worry free, slip-free performance from all Hybrid Exotic Snare Drums. (U.S. Patent #7220905, #7301087, #7365256.)

To capture sonic perfection for true professional, Pearl's latest experiments with different material combinations have yielded new tonal frontiers in our new Hybrid Exotic Series snare drums. The purest representation of Pearl's finest craftsmanship, Hybrid Exotic shell choices include spun-composite VectorCast™, dual-step seamless Cast Aluminum, and cross-laminated Kapur and Fiberglass, for the ultimate in power and prestige.



HEK1480

#### HEK1480 14" x 8"

Low, thunderous wallop with deep, solid playability.  
Shell: 6 ply 7.5mm Kapur w/Inner Fiberglass  
Hoops: SuperHoop II (SH1410B/1410S)  
Lugs: STL100  
Tension Rods: SPT5047 (top) - SST5047 (bottom)  
Strainer: SR1000  
Snares: SN1442D

#### HEK1450 14" x 5"

Articulate snare punch, best at higher tunings.  
Shell: 6 ply 7.5mm Kapur w/Inner Fiberglass  
Hoops: SuperHoop II (SH1410B/1410S)  
Lugs: STL100  
Tension Rods: SPT5047 (top) - SST5047 (bottom)  
Strainer: SR1000  
Snares: SN1420D

#### HEK1465 14" x 6.5"

Lively blend of throaty snare holler and punchy projection.  
Shell: 6 ply 7.5mm Kapur w/Inner Fiberglass  
Hoops: SuperHoop II (SH1410B/1410S)  
Lugs: STL100  
Tension Rods: SPT5047 (top) - SST5047 (bottom)  
Strainer: SR1000  
Snares: SN1420D

#### HEAL1450 14" x 5"

Dry, high-pitched crack with little overtone.  
Shell: Cast Aluminum: 3mm w/ 2mm R-Rings  
Hoops: SuperHoop II (SH1410B/1410S)  
Lugs: STL100  
Tension Rods: SPT5047 (top) - SST5047 (bottom)  
Strainer: SR1000  
Snares: SN1420I

#### HEAL1465 14" x 6.5"

Fat midrange focus without sacrificing volume.  
Shell: Cast Aluminum: 3mm w/ 2mm R-Rings  
Hoops: SuperHoop II (SH1410B/1410S)  
Lugs: STL100  
Tension Rods: SPT5047 (top) - SST5047 (bottom)  
Strainer: SR1000  
Snares: SN1420I

#### HEP1450 14" x 5"

Quick, yielding snap with heavy midrange overtones.  
Shell: VectorCast  
Hoops: SuperHoop II (SH1410B/1410S)  
Lugs: STL100  
Tension Rods: SPT5047 (top) - SST5047 (bottom)  
Strainer: SR1000  
Snares: SN1420C

#### HEP1465 14" x 6.5"

Full-Spectrum snare body with thick bottom-end tonality.  
Shell: VectorCast  
Hoops: SuperHoop II (SH1410B/1410S)  
Lugs: STL100  
Tension Rods: SPT5047 (top) - SST5047 (bottom)  
Strainer: SR1000  
Snares: SN1420C

**SEE AND HEAR**  
ALL 8 FREE FLOATING SNARE DRUMS  
[pearldrums.com/2minute](http://pearldrums.com/2minute)

**SEE AND HEAR**  
ALL 7 HYBRID EXOTIC SNARE DRUMS  
[pearldrums.com/2minute](http://pearldrums.com/2minute)



## SENSITONE

*Classic, Reliable Snare Power.*

The SensiTone sound is a necessity. Vital, immediate snare tone that recalls the chart topping legends of yesterday, but with a undeniably modern sensibility. Classic beaded shells in Steel, Nickel-Plated Brass, and Seamless Aluminum deliver the goods and the right gig-ready touches make them utility standards for the power player.



**SEE AND HEAR**  
ALL SENSITONE SNARE DRUMS  
[pearldrum.com/2minute](http://pearldrum.com/2minute)

**STA1450S** | 14" x 5"

Crisp, sensitive high-pitched snap.  
Shell: 1mm Beaded Steel  
Hoops: SuperHoop II (SH1410B/1410S)  
Lugs: TB50  
Tension Rods: SST5047  
Strainer: SR150  
Snares: SN1420I



STA1450S



STA1465S

**STA1465S** | 14" x 6.5"

Belted crack with mild midrange overtone.  
Shell: 1mm Beaded Brass  
Hoops: SuperHoop II (SH1410B/1410S)  
Lugs: TB65  
Tension Rods: SST5047  
Strainer: SR150  
Snares: SN1420I

**STA1450BR** | 14" x 5"

Perfect blend of attack and brassy body.  
Shell: 1mm Beaded Brass  
Hoops: SuperHoop II (SH1410B/1410S)  
Lugs: TB50  
Tension Rods: SST5047  
Strainer: SR150  
Snares: SN1420I



STA1450BR



STA1465BR

**STA1465BR** | 14" x 6.5"

An elegant solution for punch and warmth.  
Shell: 1mm Beaded Brass  
Hoops: SuperHoop II (SH1410B/1410S)  
Lugs: TB65  
Tension Rods: SST5047  
Strainer: SR150  
Snares: SN1420I

**STA1450AL** | 14" x 5"

Dry, focused crack with quick decay.  
Shell: 1.2mm Beaded Seamless Aluminum  
Hoops: SuperHoop II (SH1410B/1410S)  
Lugs: TB50  
Tension Rods: SST5047  
Strainer: SR150  
Snares: SN1420I



STA1450AL



STA1465AL

**STA1465AL** | 14" x 6.5"

Full, guttural snare bellow with little overtone.  
Shell: 1.2mm Beaded Seamless Aluminum  
Hoops: SuperHoop II (SH1410B/1410S)  
Lugs: TB65  
Tension Rods: SST5047  
Strainer: SR150  
Snares: SN1420I



### THROW-OFF SYSTEM: SR150 STRAINER

The secret behind Pearl's patent pending Click-Lock Strainer System is a "C"-shape clip that clicks onto the tension dial. This prevents the lever from disengaging, and the tension dial from loosening, even if the tension is very low. A Polymer bearing on the axle provides smooth and accurate action, and reliably quick response from the lever. (U.S. Patent #9082376)

ON

OFF

## SENSITONE PREMIUM

*Immaculate Percussion.*

Engineered for performance perfection, SensiTone Premium snare drums feature a choice of Patina Beaded Brass, Beaded Phosphor Bronze, or even-ply North American Maple shells. With 14" models available in 5" and 6.5" depths, the Premium line's newcomer is the new African Mahogany 15"x5" Baritone snare model, adding an additional voice to the tonal pallet.



STA1450FB



STA1465FB

**STA1450FB** | 14" x 5"

Bright and responsive with lively overtone.  
Shell: 1.5mm Beaded Brass  
Hoops: SuperHoop II (SH1410B/1410S)  
Lugs: ARL55  
Tension Rods: SST5047  
Strainer: SR150  
Snares: SN1420I

**STA1465FB** | 14" x 6.5"

Bold projection with controlled ring sustain.  
Shell: 1.5mm Beaded Brass  
Hoops: SuperHoop II (SH1410B/1410S)  
Lugs: ARL65  
Tension Rods: SST5047  
Strainer: SR150  
Snares: SN1420I



STA1450PB



STA1465PB

**STA1450PB** | 14" x 5"

Musical and penetrating with mid-range power.  
Shell: 1.2mm Phosphor Bronze  
Hoops: SuperHoop II (SH1410B/1410S)  
Lugs: ARL55  
Tension Rods: SST5047  
Strainer: SR150  
Snares: SN1420I

**STA1465PB** | 14" x 6.5"

Bellowing low-end whallop with smooth articulation.  
Shell: 1.2mm Phosphor Bronze  
Hoops: SuperHoop II (SH1410B/1410S)  
Lugs: ARL65  
Tension Rods: SST5047  
Strainer: SR150  
Snares: SN1420I



STA1450MM



STA1465MM

**STA1450MM** | 14" x 5"

Top-end projection with fat highs and mids.  
Shell: 6 ply 5.4mm Maple  
Hoops: SuperHoop II (SH1410B/1410S)  
Lugs: ARL65  
Tension Rods: SST5047  
Strainer: SR150  
Snares: SN1420D

**STA1465MM** | 14" x 6.5"

Thick snare tone with suppressed mid-tonality.  
Shell: 6 ply 5.4mm Maple  
Hoops: SuperHoop II (SH1410B/1410S)  
Lugs: ARL55  
Tension Rods: SST5047  
Strainer: SR150  
Snares: SN1420D



ARL65 ARL55

Pearl's stylish Arch-Tube Lugs come standard on all SensiTone Premium snares. The low-contact Arch casting includes two self-aligning swivel nuts rather than a contiguous tube. This allows for pristine tuning across the head and reduced margin for binding within the lug. (U.S. Patent #9502013)



STA1550MH

**STA1550MH** | 15" x 5"

The Baritone Snare; low-end tone with top-end snap.  
Shell: 4 Ply 5mm African Mahogany\*  
Hoops: SuperHoop II (SH1510B/1510S)  
Lugs: ARL55  
Tension Rods: SST5047  
Strainer: SR150  
Snares: SN1520I

\* w/ Maple Reinforcement Rings

SensiTone Premium's selection of refined percussion instruments truly demand a place of prestige, and are sure to be first-call drums for the stage, studio, and beyond.



# SIGNATURE

Capture the Elusive Sound of Your Drumming Idol.



DENNIS CHAMBERS



IAN PAICE



JOEY JORDISON



OMAR HAKIM

DC1450S/N 14" x 5"

Shell: Cast Aluminum; 3mm with 2mm R. Rings  
Hoops: SuperHoop II (SH1410B/1410S)  
Lugs: STL100  
Rods: 20; 12 (Top) + 8 (Bottom)  
Tension Rods: SST5047 Stainless Steel  
Strainer: SR020  
Snares: SN1420I  
Finish: Black Nickel Shell with Nickel Hardware



DC1450S/N

IP1465 14" x 6.5"

Shell: Beaded Steel Shell  
Hoops: SuperHoop II (SH1410B/1410S)  
Lugs: TB65  
Rods: 10  
Tension Rods: SST5042 Stainless Steel  
Strainer: SR017  
Snares: S022N  
Finish: Steel



IP1465



JJ1365N



OH1350

JJ1365N 13" x 6.5"

Shell: Steel Shell  
Hoops: SuperHoop II (SHB1308/1308S)  
Lugs: CL65B  
Rods: 8  
Tension Rods: SST5047 Stainless Steel  
Strainer: SR017/B  
Snares: S029N  
Finish: Custom Black

OH1350 13" x 5"

Shell: 6 ply African Mahogany Shell  
Hoops: SuperHoop II (SH1308/1308S)  
Lugs: CL55  
Rods: 8  
Tension Rods: SST5047 Stainless Steel  
Strainer: SR015  
Snares: S029N  
Finish: #140 Natural Mahogany

# UTILITY & EFFECTS

Versatile Drums for Secondary Effects.

MODERN UTILITY snare drums are vital instruments. Well-appointed tools of the trade crafted for the informed, current drummer to make the gig great. Priced for the active working player, Modern Utility snares are available in both 100% Maple and Beaded Steel.

Flexible enough to add to any setup and strong enough to stand up to constant play, each model has a cool, versatile vibe. Featuring our CL arch lugs and smooth SR700 snare strainer for precise tunability.



Leg Brackets: FTB07 (x3)



See Korn drummer Ray Luzier's performance test of each Modern Utility snare at [pearldrums.com](http://pearldrums.com)



MUS1455M 14" x 5.5"

Shell: 6 ply Maple (5.4mm)  
Hoops: 1.6mm Steel (RH1408/1408S)  
Lugs: CL55 (8)  
Rods: 16  
Tension Rods: TR5052  
Strainer: SR700  
Snares: SNW1420  
Finishes: #224 Matte Natural, #227 Satin Black



MUS1465M 14" x 6.5"

Shell: 6 ply Maple (5.4mm)  
Hoops: 1.6mm Steel (RH1408/1408S)  
Lugs: CL65  
Rods: 16  
Tension Rods: TR5047  
Strainer: SR700  
Snares: SNW1420  
Finishes: #224 Matte Natural, #227 Satin Black



MUS1480M 14" x 8"

Shell: 6 ply Maple (5.4mm)  
Hoops: 1.6mm Steel (RH1408/1408S)  
Lugs: CL100 (16)  
Rods: 16  
Tension Rods: TR5047  
Strainer: SR700  
Snares: SNW1420  
Finishes: #224 Matte Natural, #227 Satin Black



MUS1410FM/C 14" x 10"

Shell: Evenply-6 Maple (5.4mm)  
Hoops: 1.6mm Steel (RH1206/1206S)  
Lugs: CL100  
Rods: 16  
Tension Rods: TR5052  
Strainer: SR017  
Snares: SNW1420  
Finishes: Satin Brown (#220)



MUS1270M 12" x 7"

Shell: 6 ply Maple (5.4mm)  
Hoops: 1.6mm Steel (RH1206/1206S)  
Lugs: CL65  
Rods: 12  
Tension Rods: TR5057  
Strainer: SR700  
Snares: SNW1216  
Finishes: #224 Matte Natural, #227 Satin Black



MUS1350M 13" x 5"

Shell: 6 ply Maple (5.4mm)  
Hoops: 1.6mm Steel (RH1308/1308S)  
Lugs: CL55  
Rods: 16  
Tension Rods: TR5047  
Strainer: SR700  
Snares: SNW1316  
Finishes: #224 Matte Natural, #227 Satin Black



MUS1455S/C 14" x 5.5"

Shell: 1mm Beaded Steel  
Hoops: 1.6mm Steel (RH1408/1408S)  
Lugs: CL55  
Rods: 16  
Tension Rods: TR5052  
Strainer: SR700  
Snares: SNW1420  
Finishes: Textured Steel



MUS1465S/C 14" x 6.5"

Shell: 1mm Beaded Steel  
Hoops: 1.6mm Steel (RH1408/1408S)  
Lugs: CL65  
Rods: 16  
Tension Rods: TR5047  
Strainer: SR700  
Snares: SNW1420  
Finishes: Textured Steel

# COLLABORATION

**THE IGNITER** To capture the searing energy of drumming for a new generation of players, Pearl collaborated with viral video drummer Casey Cooper to create The Igniter. Specifically created to instantly improve the sound of any student drum kit, it's a fantastic value to keep the fire of drumming burning bright!



CC1450S/C 14" x 5"

Shell: 6-ply 6.8mm Poplar/Maple  
Hoops: 1.6mm Steel (RH1408/1408S)  
Lugs: CL55  
Rods: 16  
Tension Rods: TR5047  
Strainer: SR700  
Snares: SNW1420  
Finishes: Artisan II Flame Wrap



# EFFECTS



M1060 10" x 6"

Shell: 6 Ply Maple  
Hoops: Super Hoop II (SH1006/1006S)  
Lugs: CL65  
Rods: 12  
Tension Rods: SST5035  
Strainer: SR700  
Snares: SNW1420



M1270 12" x 7"

Shell: 8 Ply Maple  
Hoops: 1.6mm Steel (RIM1208B/1208S)  
Lugs: CL100  
Rods: 16  
Tension Rods: SST5047 Stainless Steel  
Strainer: SR018  
Snares: S031N



SFS10/C31 10" x 4.5"

Shell: 6 Ply Poplar  
Hoops: 1.6mm Steel (RIM1006RSH/RIM1006RSH)  
Lugs: MSFL35  
Rods: 12  
Tension Rods: RSHT3240  
Strainer: SR02MSFL/SR02EMSFL  
Snares: SN10MSFL

Bracket & Mount Included

# FIRECRACKER



FCP1250 12" x 5"

Shell: 8 ply Poplar  
Hoops: 1.6mm Steel (RIM1206/1206SL)  
Lugs: CL50  
Rods: 12  
Tension Rods: T062  
Strainer: SR700  
Snares: SR018

# PICCOLO



B1330 13" x 3"

Shell: Brass  
Hoops: 1.6mm Steel (RIM1308B/1308S)  
Lugs: CL05  
Rods: 16  
Tension Rods: T055  
Strainer: SR018  
Snares: S029N



S1330B 13" x 3"

Shell: Steel  
Hoops: 1.6mm Steel (RIM1308B/1308S)  
Lugs: CL05  
Rods: 16  
Tension Rods: T055  
Strainer: SR018  
Snares: S029N



M1330 13" x 3"

Shell: 6 ply Maple  
Hoops: 1.6mm Steel (RIM1308B/1308S)  
Lugs: CL05  
Rods: 16  
Tension Rods: T055  
Strainer: SR018  
Snares: S029N



FCS1050 10" x 5"

Shell: 1.0mm Steel  
Hoops: 1.6mm Steel (RIM1006/1006SL)  
Lugs: CL50  
Rods: 12  
Tension Rods: T062  
Strainer: SR018  
Snares: S032



## DEMON PEDALS

*The Fastest, Smoothest, Most Powerful Pedals in the World.*



BARRY KERCH  
SHINEDOWN

MARK BENNETT  
BARRY TECH

DIRECT LINK  
ADJUSTMENT



U.S. Patent #7579540

CONTROL  
CORE BEATERS

INDEPENDENT BEATER  
ANGLE AND FOOTBOARD  
HEIGHT ADJUSTMENTS

P3002D  
DIRECT DRIVE DOUBLE  
PEDAL (SHOWN IN  
LONGBOARD SETTING)

### DEMON DRIVE UNLEASH THE DEMON

The Demon Drive is without a doubt the most thoroughly engineered bass drum pedal the World has ever seen. Lightning fast power and silky smooth finesse make this the choice of some of the most prolific drummers in the world. An amazing array of adjustable features turns this pedal into an extension of your body. From beater angle, traction plate grip, and footboard height and angle, it's all your choice. And when you feel the need for speed the Demon quickly converts to a double pedal with a simple add on pack. Unleash the Demon and find out what custom feel is all about.

- P3000D Single Pedal Complete
- P3002D Double Pedal Complete (right footed)
- P3001D Double Pedal Conversion Kit (right footed)
- P3002DL Double Pedal Complete (left footed)

ADJUSTABLE TRACTION PLATE

DUO-DECK FOOTBOARD

P3000D  
(SHOWN IN LONGBOARD SET UP)

“Night after night, Pearl pedals provide the power, control, and reliability that is needed to take your performance to the next level.”  
- MARK BENNETT



**DIRECT LINK** The two positions adjust for a choice of light or heavy feel. This creates the most seamless link between the player's musical ideas and their execution on a bass drum.

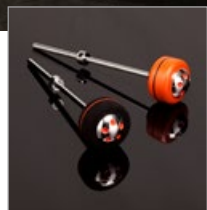

**DEMON DRIVE BEATER** features a Control Core elastomer center that eliminates unwanted vibration. (U.S. Patent #7626108)



**CLICK-LOCK** prevents the tension knob from loosening no matter how hard you play. Simply flip up for adjustment. (U.S. Patent #7754953)



**DUO-DECK FOOTBOARD** is Pearl's exclusive, world's first convertible footboard and the most unique feature of the Demon Drive pedal. Through a simple adjustment, the footboard can be adjusted from a traditional shortboard to a longboard pedal in seconds, offering a slightly lighter, quicker feel that is the preferred setup when speed is a necessity. (U.S. Patent #7626107)



**NINJA BEARINGS** were originally designed by skateboarding engineers. These bearings feature micro-polished steel balls for amazing speed and incredible smoothness.



**PERFECT CIRCLE CAM** "linear response" provides consistent and smooth feel throughout the entire stroke for pinpoint accuracy and superb control. The racing-inspired Cam is designed to minimize mass and maximize speed and power transfer.

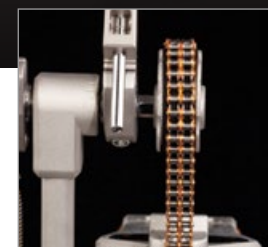

**POWER CHAIN** The Demon Chain Pedal is driven by the ultra-lightweight Power Chain with low-friction rollers for speed, and double chain construction for power and dependability. The orange anodized link plates identify the Demon Chain as a member of the Demon family of pedals.



P3002C  
Chain Drive Double Pedal (Shown In Shortboard Setting)



**Z-LINK DRIVE SHAFT** features Pearl's exclusive Zero Latency Universal Joints that use precision radial ball bearings and hand-assembled CNC machined frames for zero play and smoothness that allows your slave pedal to respond as quickly and precisely as your primary.

EQUIPMENT FAILURE IS NOT AN OPTION, END OF STORY.

Pearl's hardware is LEGENDARY. So rugged, sure-footed, and built to last that we back it up with PEARL'S EXCLUSIVE Lifetime Warranty.

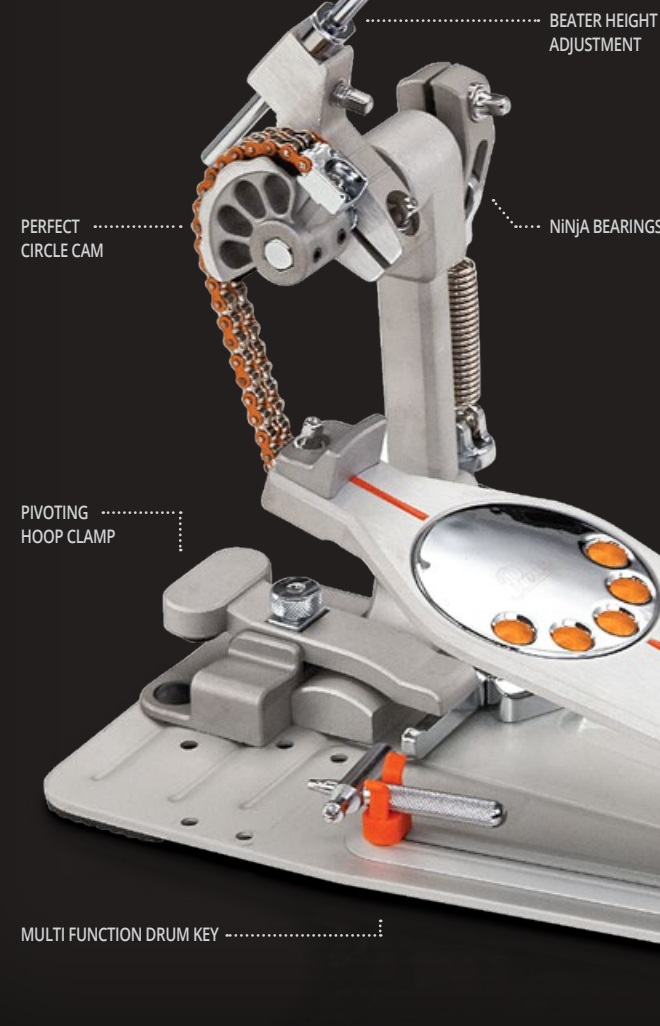

BEATER HEIGHT  
ADJUSTMENT

PERFECT  
CIRCLE CAM

NINJA BEARINGS

PIVOTING  
HOOP CLAMP

MULTI FUNCTION DRUM KEY

**SEE AND HEAR**  
DEMON DRIVE & DEMON CHAIN PEDALS  
[pearldrums.com/2minutepedals](http://pearldrums.com/2minutepedals)

**ELIMINATOR**  
**DEMON**  
HEAVENLY FEEL... WICKEDLY FAST PEDALS

### DEMON CHAIN TRADITIONAL FEEL AND POWER OF A CHAIN

The Demon Chain pedal combines all of the innovative features of the Demon Drive pedal with all the power, speed, and traditional feel that so many players demand. The Perfect Circle cam provides a smooth consistent response throughout the entire range of the stroke for pinpoint accuracy and control. If you demand the feel of a chain drive in a high performance package, take the Demon out for a test drive.

- P3000C Single Pedal Complete
- P3002C Double Pedal Complete (right footed)
- P3001C Double Pedal Conversion Kit (right footed)
- P3002CL Double Pedal Complete (left footed)

P3000C  
(SHOWN IN LONGBOARD SET UP)



# ELIMINATOR REDLINE

The Key To Ultimate Bass Drum Performance.

# ELIMINATOR REDLINE



MICHELLE BAPTISTE  
NORMANI K. HAMILTON

P2050C  
ELIMINATOR REDLINE  
SINGLE PEDAL, CHAIN DRIVE

## CHOOSE A CAM, REDLINE YOUR PERFORMANCE

Pearl's original PowerShifter Eliminator was a giant leap ahead in bass drum pedals. The world's only pedal featuring the patented Interchangeable Cam System, Eliminator's virtually unlimited tunability lets the player lock in totally personalized feel, power and speed.

The Eliminator: Redline is the next step forward. Like having four pedals in one, Redline fuses the stunning power and flexibility of the original Eliminator with the fluid speed of our Demon series pedals. With a host of radical improvements, Eliminator: Redline helps unlock perfect feel by locking in a cam, further pushing the boundaries of bass drum performance.

## ELIMINATOR REDLINE

**INTERCHANGEABLE CAM SYSTEM** U.S.PAT.#6172291

Pearl's exclusive cam system provides a choice of 6 different color-coded cams (4 included and 2 more optional) allowing you to quickly change the power and feel of the pedal to suit your individual playing needs. Changing from cam to cam is as simple as pushing the release button and snapping another in place.

<b>BLACK CAMTBK</b> Linear action cam	<b>WHITE CAMTWT</b> Oversized linear cam	<b>BLUE CAMTBL</b> Progressive cam	<b>RED CAMTRD</b> Radical progressive cam	<b>PURPLE CAMPL</b> Aggressive action cam (Optional)	<b>YELLOW CAMYL</b> Inverse action cam (Optional)

## CHAIN OR BELT DRIVE

The sprocket-less double chain drive on the Eliminator Redline (P2050C) provides super smooth action with powerful and precise feel. The Eliminator Belt Drive model (P2050B) provides a very comfortable, natural feel similar to a direct-drive system.

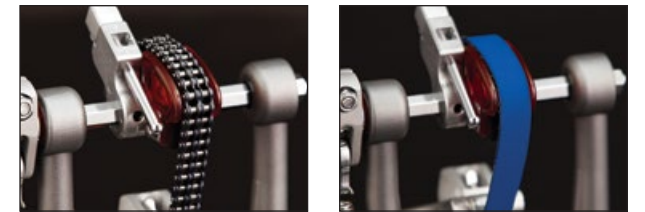

\*Shown w/ Optional Red Cam



P2052B  
ELIMINATOR REDLINE DOUBLE PEDAL, BELT DRIVE



Eliminator Redline Series pedals come standard with Custom Carry bags.



P2052C  
ELIMINATOR REDLINE DOUBLE PEDAL, CHAIN DRIVE  
SHOWN W/ INCLUDED RED CAM ATTACHED



**INDEPENDENT TRACTION GRIPS**  
The redesigned pedalboard features Pearl's exclusive reversible Traction Plate insert, allowing individual traction grip configuration to suit your exact playing requirements.



**ZERO PLAY HINGE** Our proprietary stainless steel hinge provides maximum freedom of motion for blazing speed and prevents play between the footboard and heel. U.S. Patent #7179978



**NiNja BEARINGS** Developed by skateboarding engineers for the ultimate in fast, quiet performance, NiNja Bearings incorporate state-of-the-art micro-polished steel balls for incredibly fast and smooth performance.



**ROLLER HOOP CLAMP** w/ Side Mount Adjustment. Quickly adapts to a wide range of hoop thicknesses for the smoothest, most secure grip possible. Easy side access to the hoop clamp makes set up and tear down a breeze. U.S. Patent #5726370



**THE CONTROL CORE QUADBEATER**  
Pearl's improved, reduced profile QuadBeater provides the same four beater surfaces of the original (two hard plastic, two felt). The Control Core elastomer center's added feel and power eliminates vibration. U.S. Patent #5610351 U.S. Patent #7626108



**POWERSHIFTER FUNCTION** By moving the footboard forward or back, our revolutionary PowerShifter function provides 3 positions to fine tune the power and feel of the pedal. Instantly change the drive angle leverage to create a light, regular, or strong feel. U.S. Patent #5574237



**CLICK-LOCK SPRING ADJUSTMENT** w/ Rotor Tension Cradle. Locks the desired spring settings into place and prevents tension creep under play. The counter spring adjustment's rolling cradle allows the spring to pivot with each stroke for less resistance. U.S. Patent #7754953



**UNI-LOCK BEATER ANGLE CAM** Grips the axle a full 360 degrees and allows infinite beater angle adjustments. Features the Floating Spring Pendulum design that is perfectly centered on the clamp for full bearing movement and maximum smoothness.



# P930/P932

*Speed and Control  
for the Masses.*

**SEE AND HEAR**  
THE P930 & P932 DRUM PEDALS  
[pearldrums.com/2minutepedals](http://pearldrums.com/2minutepedals)



CONTROL CORE  
BEATER

BEATER HEIGHT  
ADJUSTMENT

INTERCHANGEABLE  
CAM TECHNOLOGY

INFINITE BEATER  
ANGLE ADJUSTMENT

2 POSITION  
POWERSHIFTER  
FUNCTION

CLICK LOCK  
SPRING  
TENSION

**P930**  
SINGLE PEDAL COMPLETE

- P930 Single Pedal Complete
- P932 Double Pedal Complete (right footed)
- P931 Double Pedal Conversion Kit (right footed)
- P932L Double Pedal Complete (left footed)

## SUPER SMOOTH, EXTREMELY FAST!

Merging quick rebound response of our flagship Demon Drive with the finely-tuned control of our award-winning Eliminator models, the P930 bass drum pedal offers high-end performance at a player accessible price. Its longboard playing deck delivers a lighter feel for increased speed, and offers advanced performance control and tunability with two rotor cam options. The ultimate pedal for fast feet on a budget.

Comes standard with Perfect Circle and removable Orange Progressive Cams, for fully tunable performance and increased control.

## CONTROL CORE DUO BEATER

(U.S. Patent #7626108) utilizes an elastomer center to minimize vibration and features two unique playing surfaces (rounded felt and convex hard plastic surface) for quick-shifting tone and feel.

## POWERSHIFTER FUNCTION

(U.S. Patent #5574237) further tunes the power, feel, and leverage of the pedal by shifting the chain angle forward for lighter feel, or back for increased power.



## P932 DOUBLE PEDAL COMPLETE

Double the speed, power and control with the P932 Demon Deuce. Give your feet the gift of speed at a fraction of the cost of other "less innovative" pedals.

**P932**  
DOUBLE PEDAL COMPLETE



ORANGE PROGRESSIVE CAM can be removed to reveal the Perfect Circle for further tunability to match your playing style.  
U.S. Patent #6172291



CLICK-LOCK SPRING TENSION maintains perfect tension gig after gig. Set it and forget it. U.S. Patent #7754953



The P930 pedal is included as an upgrade in the 830 Series hardware pack and comes with Export and Export Lacquer drum sets.



## P920/P922 POWERSHIFTER

*Fine-Tuned Power and Precision.*

### THE FAST TRACK TO BASS DRUMMING SPEED AND POWER

Fine-Tuned for a more refined playing experience, the P920 bass drum pedal, featuring the patented Powershifter system (U.S. Patent #5574237), helps you modify your playing approach with an adjustable three position heel plate.

Locking the plate in forward, middle, or aft positions changes the chain drive angle and delivers light, standard, or strong feel with fast, accurate beater action.



Removing resistance from your playing stroke, the Perfect Circle chain-drive cam delivers smooth, gearless action for speed, accuracy, and increased power.

Pedal tension and rebound are easily adjustable with a locking two stage spring system.



The included two-surface DuoBeater helps you modify the tone of the bass drum strike. Selecting the hard plastic surface delivers more tonal attack, while the felt surface offers increased "give" in the stroke with increased low end.

P920  
SINGLE PEDAL COMPLETE



### P922 DOUBLE BASS DRUM PEDAL

The Powershifter double pedal offers the same individual playing feel from both pedals when attached to a single kick drum. Each pedal is individually adjustable with the adjoining universal joint accurately capturing every stroke with exceptional accuracy. Each two surface DuoBeater is easily switchable and angle adjustable for personalized action and quick response.

P922  
DOUBLE PEDAL COMPLETE

“From entry level to high end, Pearl pedals deliver!”

- LESTER ESTELLE  
KELLY CLARKSON / SESSIONS

## P530/P830

*Speed, Power, and Value.*

### P530 DRUM PEDAL

With all the speed and function of a pro bass drum pedal at half the price, Pearl's P530 Bass Drum Pedal features a dual chain and Linear Action cam drive for smooth, traditional pedal action and speed. The radius rod frame makes it highly portable for gigging, while features like a two surface DuoBeater and rotor tension axle clamp make it adaptable to virtually any feel or playing style.



P530  
SINGLE PEDAL COMPLETE

### P830 DRUM PEDAL

Light in weight but not in features, the P830's Demon-style longboard increases playing surface for maximum leverage and speed. Its fully adjustable beater angle, Perfect Circle single chain cam, and DuoBeat two-surface beater deliver customizable feel for the player on the move.

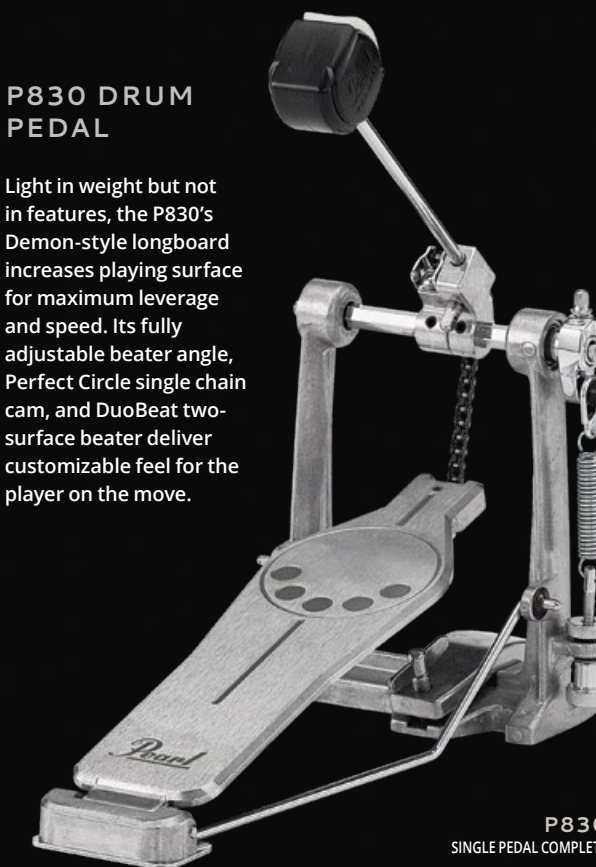

P830  
SINGLE PEDAL COMPLETE

LESTER ESTELLE  
KELLY CLARKSON / SESSIONS



## HI-HAT STANDS

### Biggest Advancement In Time-Keeping Since The Wristwatch.

Sharing many of the key characteristics of new Eliminator Redline bass drum pedals, 2050 Series Hi-Hat Stands deliver unparalleled versatility and customization in hi-hat pedal control. The world's-only hi-hat stand featuring the Interchangeable Cam System, 2050 Series stands' customizable options are designed to eliminate resistance, reduce fatigue, and increase performance.

The RH2050 Remote Hi-Hat's low-friction cable produces smooth, lag-free performance with the lightning-fast action of the PosiLink Twin Cam drive system. Fast, natural-feeling cymbal play is finally accessible virtually anywhere on the kit, or to facilitate multiple hi-hat system setups.



CLH930

- Closed Hi-Hat
- Uni-Lock Tilter
- Knurled Boom Arm
- UltraGrip Wing Nuts / Wing Bolts

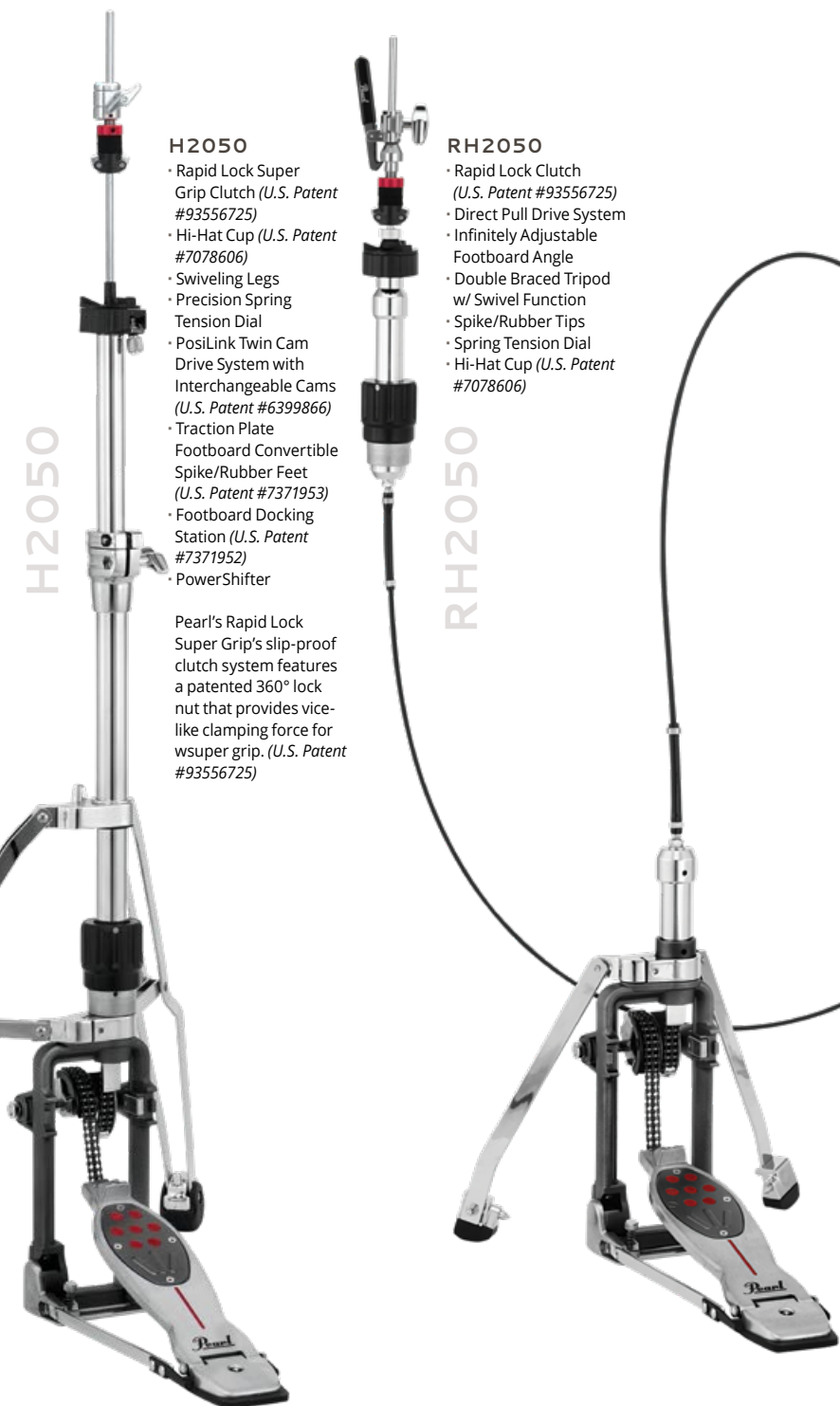

H2050

RH2050

- Rapid Lock Super Grip Clutch (U.S. Patent #93556725)
- Hi-Hat Cup (U.S. Patent #7078606)
- Swiveling Legs
- Precision Spring Tension Dial
- PosiLink Twin Cam Drive System with Interchangeable Cams (U.S. Patent #6399866)
- Traction Plate
- Footboard Convertible Spike/Rubber Feet (U.S. Patent #7371953)
- Footboard Docking Station (U.S. Patent #7371952)
- PowerShifter

- Rapid Lock Clutch (U.S. Patent #93556725)
- Direct Pull Drive System
- Infinitely Adjustable Footboard Angle
- Double Braced Tripod w/ Swivel Function
- Spike/Rubber Tips
- Spring Tension Dial
- Hi-Hat Cup (U.S. Patent #7078606)

Pearl's Rapid Lock Super Grip's slip-proof clutch system features a patented 360° lock nut that provides vice-like clamping force for wsuper grip. (U.S. Patent #93556725)



BRIAN FRASIER-MOORE  
JUSTIN TIMBERLAKE

“Night in and night out Pearl hardware keeps everything right where it should be, and without fail!”  
- OKWA ANDREWS

OKWA ANDREWS  
BRIAN'S TECH



H1050

H930

H830

H150S

- Rapid Lock Clutch (U.S. Patent #93556725)
- Direct Pull Drive System
- Infinitely Adjustable Footboard Angle
- Double Braced Tripod w/ Swivel Function
- Spike/Rubber Tips
- Spring Tension Dial
- Hi-Hat Cup (U.S. Patent #7078606)

- Direct Pull Drive System
- Precision Spring Tension Dial
- Double Braced Tripod w/ Swivel Function
- SureGrip Oversize Rubber Feet
- Demon Style Long Board Footboard

- Demon Style Long Footboard (single color footboard)
- Double Braced Tripod w/ Swivel Function

- Light Weight (6.30 lbs.)
- Stable Flat-Based Tripod
- Swivel Function Allows Easy Double-Pedal Positioning
- Direct-Pull Drive System
- Spring Tension Adjustment
- Redline Traction Plate Footboard



**INDEPENDENT TRACTION GRIPS** Like all Eliminators, the pedal has removable traction grip inserts that can be adjusted or removed to tailor the amount of grip or slip. The plate is even reversible for more choices.



**H2050 PRECISION SPRING TENSION DIAL** allows absolute perfect tension control for the ultimate in fine-tunable response.



HA130

HA130 positions your hi-hat next to your bass pedal in double bass set-ups for super quick transitions between pedals.



**H1050 PEDAL HEIGHT ADJUSTMENT** The H2050 and H1050 features our infinitely adjustable footboard angle adjustment. This allows precise height matching when using multiple pedal setups.



**H1050 HI-HAT STAND** H2050 and H1050 Hi-Hat Stand uses beefy 1" tubing and clamshell clamps with built in memory locks for superior rigidity.

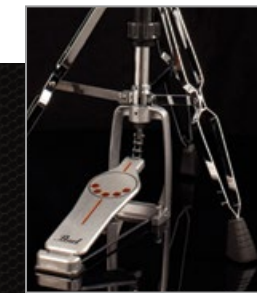

**H930 HI-HAT STAND** H930 Hi-Hat Stand features our Demon style longboard, double braced tripod w/ swivel function, and precision tension dial.



**H830 HI-HAT STAND** H830 Hi-Hat Stand is standard equipment with our Export series and offers a monochromatic Demon Style longboard design and swivel tripod.



\*Toe Stopper Not Included

**H150S\* FLAT-BASED SWIVELING HI-HAT** The H150S independent tripod is positioned separately from the pedal frame making it the only flat-based hi-hat stand with swiveling legs.



## SNARE STANDS

*Every Snare Should Be So Lucky.*

Every gig is different, and so is every snare drum. But no matter the gig or the snare drum, we have a stand to accommodate both.

Our premiere S1030 model offers chameleon like diversity for stage or studio.



The S930 offers similar features but uses our legendary Uni-Lock tilter and is also available as a drop basket version.



- S1030**
- GyroLock Tilter
  - Air Suspension Rubber Tips (U.S. Patent #6710236)
  - Trident Tripod
  - Oversize Super Grip Rubber Feet
  - Fits Snares 10" - 16"
  - Height Range of 470-660mm



- S930**
- Uni-Lock Tilter
  - Air Suspension Rubber Tips (U.S. Patent #6710236)
  - Double Braced Trident Style Tripod
  - Fits Snares 10" - 14"
  - Height Range of 450-630mm

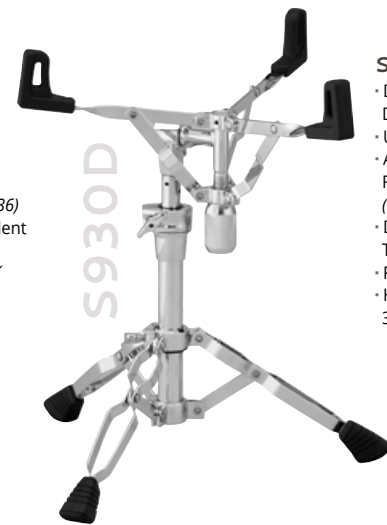

- S930D**
- Drop Basket for Deeper Snares
  - Uni-Lock Tilter
  - Air Suspension Rubber Tips (U.S. Patent #6710236)
  - Double Braced Trident Style Tripod
  - Fits Snares 10" - 14"
  - Height Range of 360-540mm



**S1030 SNARE STAND GYROLOCK** Our premier S1030 model features Pearl's 360 degree infinitely adjustable GyroLock tilter for ease-of-use and pinpoint positioning.



**S1030 SNARE BASKET** The Pearl S1030 Snare Stand adjusts to fit virtually any size snare from 10" to 16". The Air Suspension rubber tips securely cradle your prized snares while allowing them to fully resonate. (U.S. Patent #6710236)

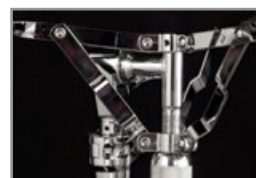

**S930D SNARE BASKET** The S930D Snare Stand is a shorter version of the S930 Snare Stand, and is built to comfortably accommodate deeper snare drums.



**SPIKED / RUBBER FEET** Our CVT300/3 Push Button Spiked/Rubber Feet come in pack of 3 to retrofit on any of our 1030 Series hardware for sure-footed performance on any terrain. (U.S. Patent #7371953)



- S830**
- Uni-Lock Tilter
  - Double Braced Tripod
  - Fits Snares 13" - 14"
  - Height Range of 430-620mm



- S150S**
- Light Weight (5.18 lbs.)
  - Stable Flat-Based Tripod
  - Gearless Uni-Lock Basket Tilter
  - Convertible Tripod or Flat-Based Legs

Our S830 model is standard equipment with our Export line. Lightweight, yet rigidly strong, it's perfect for the local gig and makes load in at the club a breeze.



S150S Convertible Tripod Base

## DRUM THRONES

*Sound Ergonomics.*

Next to your drums, your throne could be your most important piece of gear. A great throne will prevent fatigue, promote great form and posture to keep you going for those second and third encores night after night. Our thrones offer advanced ergonomic design, sturdy wide footprints for stability and a wide selection of cushion tops to provide your desired level of softness or firmness.

*"Pearl hardware is second to none! As a touring drum tech, I need hardware that doesn't break. Pearl delivers every show, every time."*

- NICK THIEME



NICK THIEME  
SHAUN'S TECH

SHAUN FOIST  
BREAKING BENJAMIN



- D2500BR**
- Motorcycle-Style Cushion
  - Detachable Backrest Mounts via Single Knob
  - Reversible Stoplock Collar
  - Height Range of 495-665mm



- D2500**
- Motorcycle-Style Cushion
  - Accepts Backrest
  - Reversible Stoplock Collar
  - Height Range of 495-665mm



- D1000N**
- Round Vinyl Cushion
  - Reversible Stoplock
  - Height Range of 495-665mm
  - D1000SN "Short" Version 455-625mm also available



- D1000SPN**
- Round Vinyl Cushion
  - Built In Shock Absorber Post with Adjustable Spring Tension
  - Reversible Stoplock
  - Height Range of 525-630mm

D2500BR

D2500

D1000N

D1000SPN



- D930**
- Round Vinyl Cushion
  - Double Braced Legs
  - Height Range of 470-660mm

D930



- D790**
- Round Vinyl Cushion
  - Height Range of 450-650mm

D790



- D730S**
- Round Vinyl Cushion
  - Single Braced Tripod
  - Height Range of 400-580mm

D730S



- D50**
- Round Vinyl Cushion
  - Double Braced Tripod
  - Height Range of 495 - 620mm

D50



### SHOCK ABSORBER

The D1000SPN Series features a firm vinyl covered cushion and a shock absorbing post for outstanding comfort, along with adjustable spring tension for customizable support.



### LOCK/SPIN SYSTEM

D2500 and D1000 Series Thrones are equipped with Pearl's exclusive Lock/Spin System. By reversing the StopLock, the cushion can be locked to prevent turning or allowed to spin depending on your preference.



### HEIGHT COLLAR

features a hinged Stop Lock and vise-like clamshell design for non-slip security.



## CYMBAL STANDS

Welcome to Boom Town.

Your hardware has to work as hard you do. Sometimes it's what separates good drummers from the great. Our hardware is road-ready and street-wise. Strong, rigid and durable yet incorporating sophisticated refinements and innovations. Our BC2030 is the most technically advanced boom stand ever devised. It's perfect for the studio musician and offers an unbelievable range of positioning for your prized cymbals.



**WINGLOC (U.S. Patent #6884015)**  
Pearl's WingLoc Quick Release Wing Nut snaps open and snaps closed for super quick removal and attachment.



**THE TRIDENT TRIPOD** uses a full 360° of clamping force via the hinged collar. The inner tube rests in a nylon bushing to prevent metal to metal contact. Heavy duty legs feature lateral bracing for superior ultra quiet rigidity.

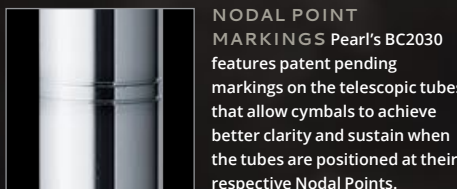

**NODAL POINT MARKINGS** Pearl's BC2030 features patent pending markings on the telescopic tubes that allow cymbals to achieve better clarity and sustain when the tubes are positioned at their respective Nodal Points.



**GYROLOCK TILTERS** are infinitely adjustable and provide 360 degree range of motion for precise positioning with one-step convenience.

**REVERSIBLE SEAT CUP (U.S. Patent #6940006)** The seat cup is specially designed to "float" normally or it can be reversed and "locked" to prevent noise during recording.

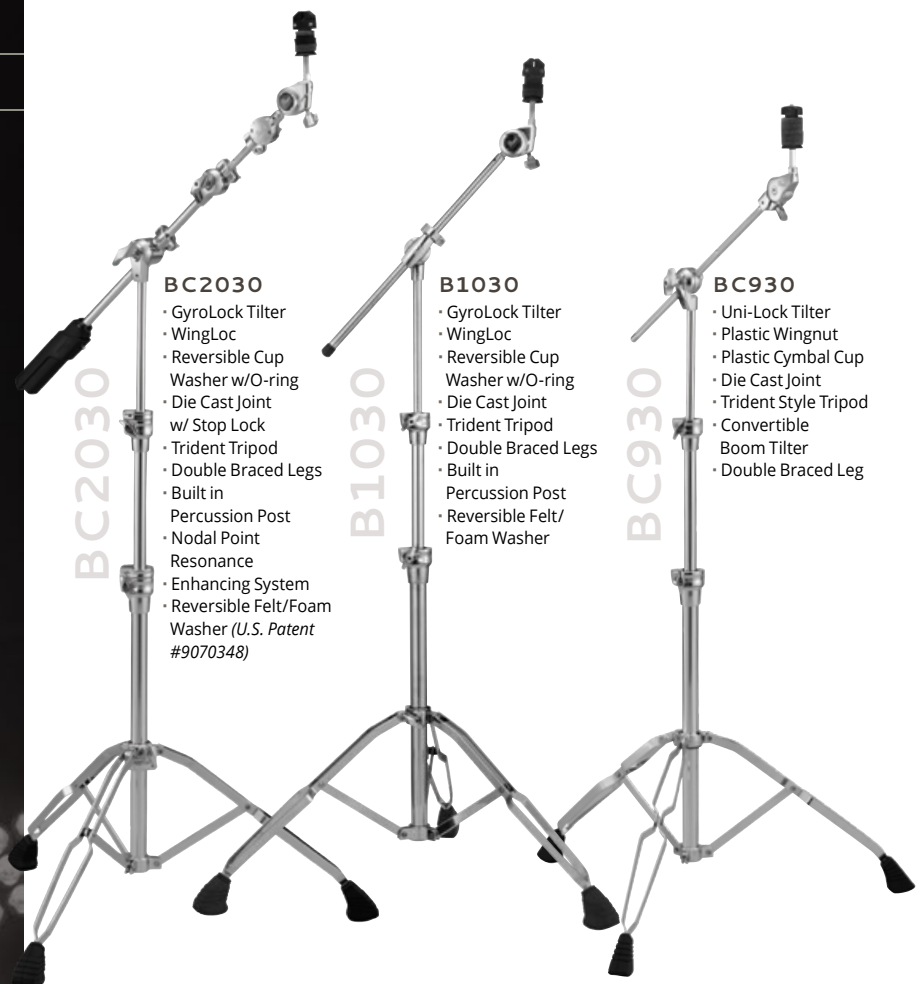

### BC2030

- GyroLock Tilter
- WingLoc
- Reversible Cup Washer w/O-ring
- Die Cast Joint w/ Stop Lock
- Trident Tripod
- Double Braced Legs
- Built in Percussion Post
- Nodal Point Resonance
- Enhancing System
- Reversible Felt/Foam Washer (U.S. Patent #9070348)

### B1030

- GyroLock Tilter
- WingLoc
- Reversible Cup Washer w/O-ring
- Die Cast Joint
- Trident Tripod
- Double Braced Legs
- Built in Percussion Post
- Reversible Felt/Foam Washer

### BC930

- Uni-Lock Tilter
- Plastic Wingnut
- Plastic Cymbal Cup
- Die Cast Joint
- Trident Style Tripod
- Convertible Boom Tilter
- Double Braced Leg

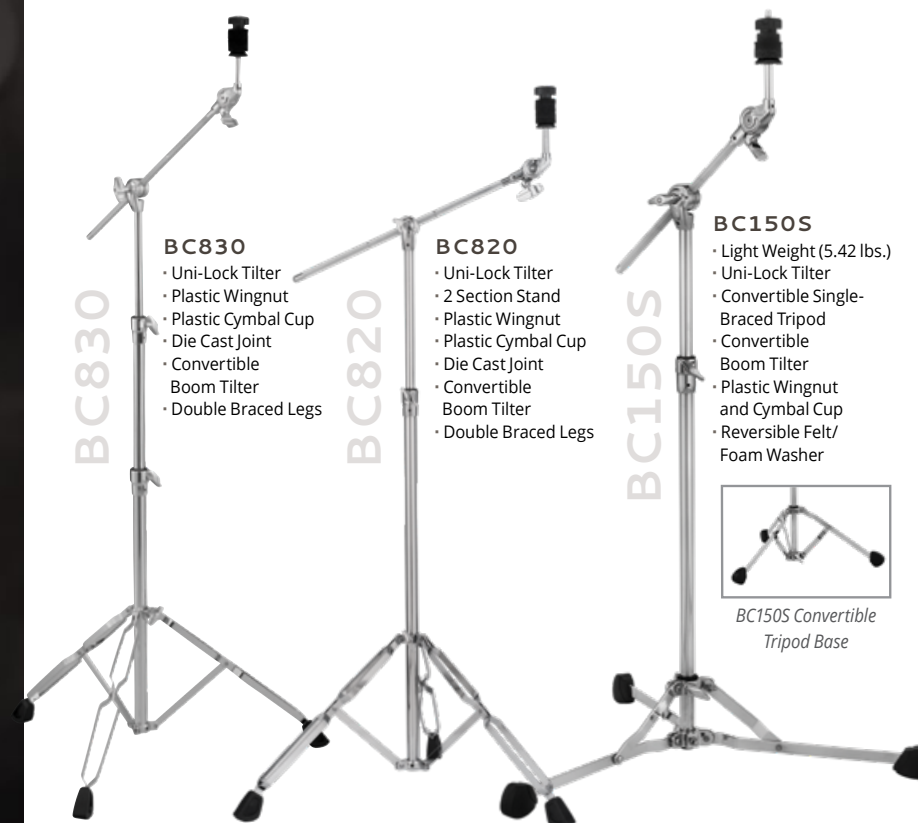

### BC830

- Uni-Lock Tilter
- Plastic Wingnut
- Plastic Cymbal Cup
- Die Cast Joint
- Convertible Boom Tilter
- Double Braced Legs

### BC820

- Uni-Lock Tilter
- 2 Section Stand
- Plastic Wingnut
- Plastic Cymbal Cup
- Die Cast Joint
- Convertible Boom Tilter
- Double Braced Legs

### BC150S

- Light Weight (5.42 lbs.)
- Uni-Lock Tilter
- Convertible Single-Braced Tripod
- Convertible Boom Tilter
- Plastic Wingnut and Cymbal Cup
- Reversible Felt/Foam Washer



BC150S Convertible Tripod Base

FOR EVERY CYMBAL, THERE IS A PLACE.

Nothing takes more abuse than your cymbal stands. Constant practice, tear 'em down throw 'em in the back of your ride, load 'em in at the gig. Abuse 'em a couple of hours on stage then start all over again. Those clamps and tilters take a lot of abuse that's why Pearl is the choice of the serious working drummer. We've been advancing drum hardware since 1946 so if you're serious about drumming, get serious about your hardware.

TRACY BROUSSARD  
BLAKE SHELTON



“Pearl hardware is literally the only hardware that you'll ever have to buy and it's all backed by their incredible lifetime warranty!”

- TRACY BROUSSARD



**830 SERIES STANDS** offer lighter weight while incorporating many of the 1030 series designs. The tripod uses Trident style design with double braced legs. Large easy to use wingnuts and lateral struts for optimal stability.

C150S  
Convertible  
Tripod Base



**CLAMSHELL** designed Die Cast joint on 2030, 1030, 930 series Boom and Straight cymbal stands, provides superhuman clamping force. Set your position, lock it down and walk away.

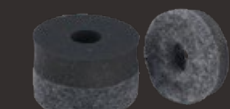

**REVERSIBLE FELT / FOAM CYMBAL WASHERS** allow four-way control of cymbal "ring" by mixing and matching the "hard" and "soft" surfaces of the washers.

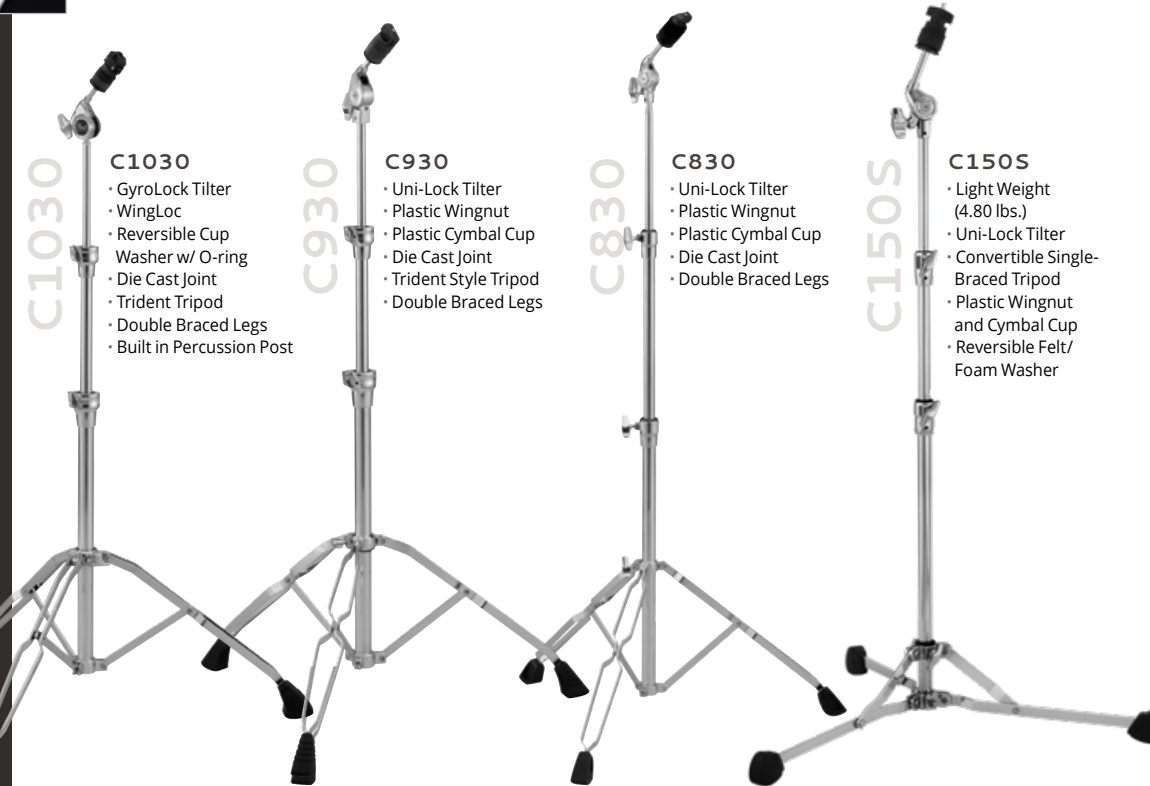

### C1030

- GyroLock Tilter
- WingLoc
- Reversible Cup Washer w/ O-ring
- Die Cast Joint
- Trident Tripod
- Double Braced Legs
- Built in Percussion Post

### C930

- Uni-Lock Tilter
- Plastic Wingnut
- Plastic Cymbal Cup
- Die Cast Joint
- Trident Style Tripod
- Double Braced Legs

### C830

- Uni-Lock Tilter
- Plastic Wingnut
- Plastic Cymbal Cup
- Die Cast Joint
- Double Braced Legs

### C150S

- Light Weight (4.80 lbs.)
- Uni-Lock Tilter
- Convertible Single-Braced Tripod
- Plastic Wingnut and Cymbal Cup
- Reversible Felt/Foam Washer



# ICON RACK SYSTEM

*The Original Drum Rack, Expanded.*

Developed in 1983 with legendary Toto drummer Jeff Porcaro, Pearl's original DR1 Drum Rack was the first freestanding, frame based drum support system available.



## RACKS

Preconfigured single and three-sided rack packages the upgraded rotating support foot.

MASTERWORKS CUSTOM KIT  
IN SATIN WHITE LACQUER WITH PIANO BLACK STRIPES, WITH BLACK CHROME HARDWARE

Now, in celebration of 35 years of pioneering the drum rack, Pearl expands the ICON (short for Independent CONtrol) Rack system with a fresh selection of upgrades and high function mounting options.

MASTERS MAPLE/GUM SHELL PACK (MMG924XSP/C)  
IN #186 HAND RUBBED NATURAL MAPLE FINISH WITH ADDED 14"X14" FLOOR TOM (MMG1414F/C)



**DR100T**  
DRUM RACK MOVEABLE  
SUPPORT T-LEG



**DR511**  
SINGLE DRUM RACK, STRAIGHT  
(w/ PCX100X2 & PCL100X2)



**DR511C**  
SINGLE DRUM RACK, CURVED  
(w/ PCX100X2 & PCL100X2)



**DR511CE**  
CURVED DRUM RACK EXPANSION BAR  
w/ SUPPORT LEG



**DR511E**  
STRAIGHT DRUM RACK EXPANSION BAR  
w/ SUPPORT LEG



**DR513**  
THREE-SIDED DRUM RACK, STRAIGHT  
(w/ PCX100X4 & PCL100X2)



**DR513C**  
THREE-SIDED DRUM RACK, CURVED  
(w/ PCX100X4 & PCL100X2)



# RACK ACCESSORIES

*An Industry Icon -  
The Professional's Choice.*

**ICON RACK RECIPES:** To explore all the possibilities in the ICON canon, check out Pearl's ICON Rack Recipe videos at [www.pearlrackrecipes.com](http://www.pearlrackrecipes.com) for step-by-step instructions on how to get the most from existing and available Pearl Rack parts.

## MOUNTING CLAMPS

Developed for the slip resistant ICON square rack rail and round support pipe. Each dramatically increases the level of setup flexibility and function variety.



**PCL100**  
EXPANDABLE PIPE CLAMP  
fits all ICON Rack Leg Posts



**PCR100**  
DUAL PIPE CLAMP



**PCR200**  
PIPE TO RAIL CLAMP



**PCR200L**  
PIPE TO RAIL CLAMP



**PCR50X**  
ROTATING PIPE  
ACCESSORY CLAMP



**PCR50L**  
PIPE ACCESSORY CLAMP



**PCL50R**  
ROTATING DUAL PIPE CLAMP



**AL86AC**  
CURVED RACK RAIL  
Short w/ Clamp



**AL103A**  
CURVED RACK RAIL  
Medium w/ End Caps



**P38475TA**  
ICON SUPPORT FOOT  
w/ TLJ200 T-Clamp



**PCX100**  
RAIL ACCESSORY CLAMP  
Clamp System w/ Adjustable Jaw



**PCX200**  
ROTATING RAIL ACCESSORY CLAMP  
Tilting Clamp System w/ Adjustable Jaw



**PCX300**  
EXTENDED ROTATING  
RAIL ACCESSORY CLAMP



**PC8**  
PIPE CLAMP  
Fits 7/8" tubes, for DR80



**RJ50**  
ICON  
6" MINI-EXPANSION BAR



**RJ100**  
PIPE JOINT  
for DR100L / DR100R



**ADP20\***  
2 Clamps  
fits 5/8" to 1-1/8"

**AX25\***  
2 Revolving Clamps  
fits 1/2" to 1-1/8"

**AX25L\***  
2 Revolving Clamps  
fits 1/2" to 1-1/8"

**AX28\***  
In-Line & Revolving Clamps  
fits 5/8" to 1-1/8" & 1/2" to 1-1/8"

**ADP30\***  
fits 3/8" to 1-1/4"  
3 Adjustable Clamps

# TOM STANDS / ARMS

*Positioning Possibilities  
Never Before Attainable.*

Our T/TC1030 Series features our GyroLock tilter for an infinite 360 degree range of movement. The T/TC930 Series use our Uni-Lock tilter for 180 degrees of motion. Our TH88 and TH70 Tom Arms Series use our dependable gear tilter.



GYROLOCK

UNI-LOCK

GEAR TILTER



T1030



T930



TC1030B



TC930



CH1030B

CH930

CH830



CH1030BS

CH930S

CH830S



CHC200



CHC100



CH70

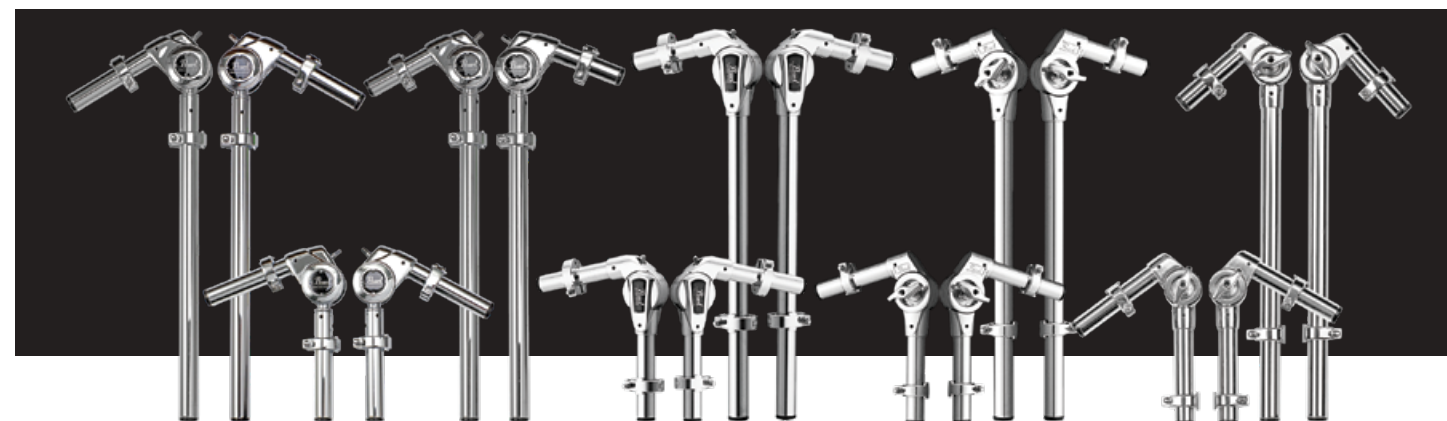

TH1030

TH1030S

TH1030I

TH900

TH900I

TH88S

TH88I

TH70S

TH70I

UX80 & UX80S Universal Clamps feature rotating infinitely adjustable clamps for multiple uses. The TX100 accepts 7/8" dia. tubes making it ideal for extending the height of snare stands.



UX80S UX80

TX100  
HEIGHT EXTENDER 13" TUBE



**PMBDL3/C**  
CHROME MULTI BASS DRUM LEGS

Multi-Bass Drum Legs allow any bass drum to be played horizontally. Height and tilt adjustable. (Patent Pending)



**CHB830**  
BASS DRUM MOUNT CYMBAL HOLDER

Mounts directly to the bass drum.



**SIGNATURE CONGAS & BONGOS**

*The Pros Play Pearl!*

**BOBBY ALLENDE**

Signature Fiberglass Congas and Bongos #617 Confetti

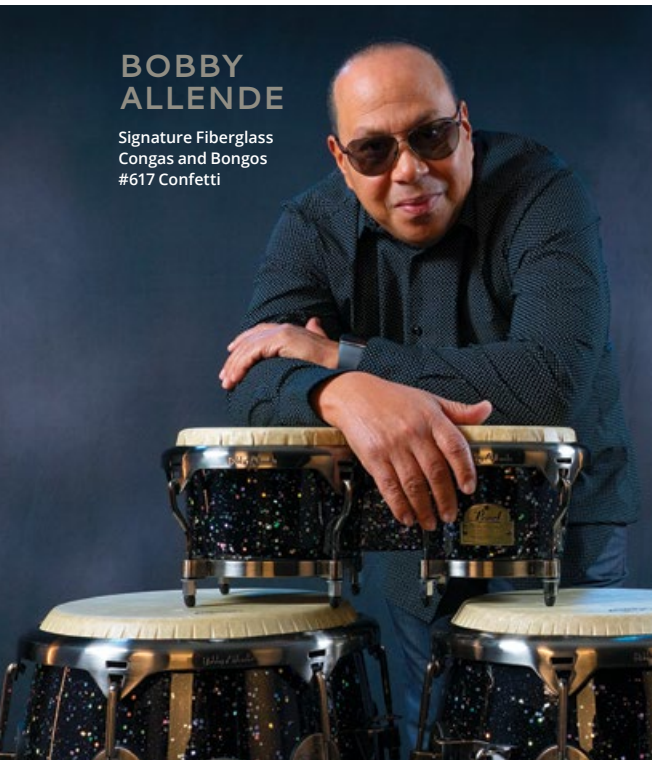

**CONGAS**  
PCF110DXBA617 11" QUINTO  
PCF117DXBA617 11.75" CONGA  
PCF125DXBA617 12.5" TUMBA

**BONGOS**  
PBF300DXBA617 7" & 8.5"



**PRP140**  
Conga Reso-Plates

**CONGA RESO-PLATE** Designed for the seated conga player, Pearl's Reso-Plate will give you that hard surface desired for maximum resonance. Configured with a cutout handle, the plates can also easily be placed on top of your drums for extra protection when packed in your conga case.



**AARON DRAPER** JOHN MAYER / ADELE / EMINEM  
**ANDY FARAG** UMPHREYS MCGEE  
**ARCHIE PENNA** SHAKIRA  
**BRETT BAKER** EMINEM / RIHANNA

**BOBBY ALLENDE SIGNATURE FIBERGLASS CONGAS AND BONGOS**

Bobby demands the best, so he designed his Signature Congas and Bongos to exceed all existing standards, right down to the smallest details. For example, the seams are invisible thus giving his Fiberglass congas the look of wood. The beauty of these drums is more than skin deep, the thick fiberglass shells produce a rich tone and projection sure to get you noticed. The congas stand 28" tall to fit the traditional seated player and the wider base adds even more projection and stability. The superior rim design of the polished Contour Crowns on both the congas and bongos adds significant comfort for the player while complimenting the Remo heads. The drums feature a new super high gloss lacquer in #617 Confetti, personally designed by Bobby.



**PEARL PERCUSSION ARTISTS**

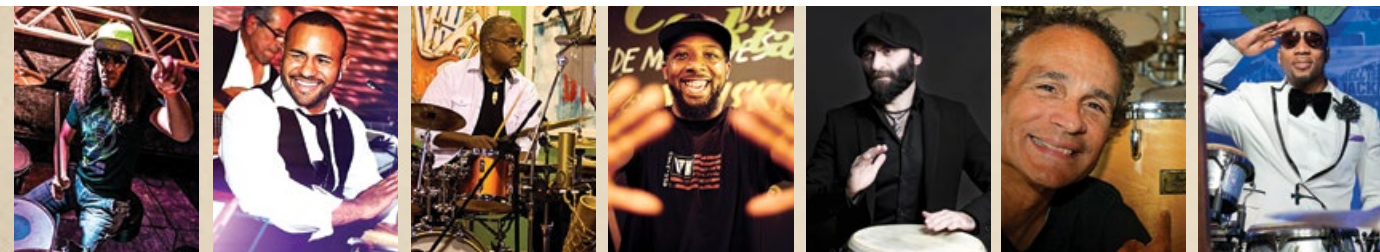

**CAMILO QUINONES** CQTHEDRUMMER / TWZTDADIO  
**CHRISTIAN PEPIN** INDEPENDENT  
**DIMAS SANCHEZ** RICO MONACO, IBA ASE  
**DOMINIQUE THOMAS** JOHN LEGEND  
**EMRAH KOTAN** INDEPENDENT  
**ETTIENNE FUENTES** INDEPENDENT  
**FRANK KNUCKLES** INDEPENDENT



**JESSIE CARABALLO** MARC ANTHONY  
**JOSE ROSA** INDEPENDENT  
**LALO DAVILA** MTSU  
**MARCO "ITO" ARGUINZONI** TITO NIEVES  
**OG** SLIGHTLY STOOPID  
**OMAR LEDEZMA** INDEPENDENT  
**PAPO PEPIN** CONGA LEGEND

**RICHIE FLORES**

Signature Oak Congas and Bongos #528 Tropical Rainbow



**CONGAS**  
PCW110DXRF528  
PCW117DXRF528  
PCW125DXRF528  
**BONGOS**  
PBW528DXRF528

11" QUINTO  
11.75" CONGA  
12.5" TUMBA  
  
7" & 9"

**RICHIE FLORES SIGNATURE OAK CONGAS AND BONGOS**

If you are searching for the authentic sound of wood, Richie's Oak congas and bongos will appeal to you. Designed by one of the most technically proficient conga players on the planet, Richie personally selected the new finish for his drums. #528 Tropical Rainbow features a rainbow effect of colors inspired by the Caribbean and Central American region Richie calls home. The high gloss lacquer finish is as unique as Richie's playing and sure to get you noticed. Richie's signature drums feature Contour Crown rims with a radical sloping edge that practically disappears under your hands for comfort you have to experience to believe. The drums also feature Pearl's exclusive Self-Aligning Washer System for effortless tuning of the natural buffalo skin heads.



**RAVI JAKHOTIA** RAVI DRUMS  
**ROLANDO MORALES MATOS** THE LION KING  
**SAMMY FIGUEROA** INDEPENDENT  
**SAMMY GARCIA** INDEPENDENT  
**TRILOK GURTU** INDEPENDENT  
**VALERIE DEE NARANJO** SATURDAY NIGHT LIVE  
**ZIG WAJLER** HANDS ON WITH ZIG

**JESUS DIAZ**

**JESUS DIAZ SIGNATURE OAK CONGAS AND BONGOS**



PHOTO: LISA KEATIN

Cuban born Jesus Diaz is one of the most in demand percussionists and vocalists on the scene today. His active schedule provided the feature set for his signature series of congas and bongos. Designed for the seated player the Thai Oak drums measure 30" tall and from the Quinto to Tumba feature added girth to the belly of the drum. Seated conga players typically have to tilt the drum to achieve the desired projection, but the Jesus Diaz drums feature a 4" port on the front of the drum that is strategically positioned to deliver the maximum base frequency while the drum remains flat on the floor. The drums also feature a newly designed Quick Release lug that is slotted to allow removal of the tension rod without fully removing the nut. Player comfort was also considered in the design of the hoop. A new ergonomically friendly design reduces the impact to your hands while an internal ring centers the head for accurate placement. The drums are finished in a matte lacquer titled Brushed Platinum #580 and feature natural buffalo skin heads.



Signature Oak Ported Congas and Bongos #580 Brushed Platinum

**CONGAS**  
PCW110DXPJD580 11" QUINTO  
PCW117DXPJD580 11.75" CONGA  
PCW125DXPJD580 12.5" TUMBA  
**BONGOS**  
PBW300DXJD580 7" & 8.5"



# CONGAS & BONGOS

*Tools of the Trade.*



## ELITE SERIES

Pearl has congas to meet the needs of every player from seasoned professionals to beginners. Our Elite Series offers the highest quality heads with polished Contour Crown rims and a choice of shell materials: 100% Thai Oak, seamless Fiberglass or a blended Oak/Fiber shell that offers the warmth of a wood shell with the added projection of Fiberglass. The Havana Series offers a wide belly design with Fiberglass shells that deliver a rich full tone. Our Primero Pro Series features professional-quality construction at an affordable price and a choice of 100% Thai Oak or Fiberglass. The Primero

line is ideal for students, band programs and beginners and features outstanding Pearl quality along with the same choice of 100% Thai Oak and Fiberglass. The Field Percussion Series features Fiberglass shells and heads that were designed for outdoor use by band programs. From the touring professional to the beginning student, Pearl has a series of congas to meet your needs.

Our bongos offer professional features and authentic styling in a choice of shell materials to perfectly match your conga set.



**ELITE WOOD-FIBER CONGAS**  
 PWFC110DX648 11" QUINTO  
 PWFC117DX648 11.75" CONGA  
 PWFC125DX648 12.5" TUMBA  
 #648 Maduro Brown

**ELITE WOOD-FIBER BONGOS**  
 PWFB100DX648 7" & 8.5"  
 #648 Maduro Brown



**ELITE FIBERGLASS CONGAS**  
 PCF110DXA 11" QUINTO  
 PCF117DXA 11.75" CONGA  
 PCF125DXA 12.5" TUMBA  
 #641 Blue Sparkle Burst

**ELITE FIBERGLASS BONGOS**  
 PBF300DXA 7" & 9"  
 #641 Blue Sparkle Burst



**ELITE OAK CONGAS**  
 PCW110DX504 11" QUINTO  
 PCW117DX504 11.75" CONGA  
 PCW125DX504 12.5" TUMBA  
 #504 Mocha Burst

**ELITE OAK BONGOS**  
 PBW300DX504 7" & 8.5"  
 #504 Mocha Burst



**ELITE OAK CONGAS**  
 PCW110DX506 11" QUINTO  
 PCW117DX506 11.75" CONGA  
 PCW125DX506 12.5" TUMBA  
 #506 Merlot Burst

**ELITE OAK BONGOS**  
 PBW300DX506 7" & 8.5"  
 #506 Merlot Burst



**ELITE OAK CONGAS**  
 PCW110DX510 11" QUINTO  
 PCW117DX510 11.75" CONGA  
 PCW125DX510 12.5" TUMBA  
 #510 Caramel Brown

**ELITE OAK BONGOS**  
 PBW300DX510 7" & 8.5"  
 #510 Caramel Brown



**ELITE OAK CONGAS**  
 PCW110DXG 11" QUINTO  
 PCW117DXG 11.75" CONGA  
 PCW125DXG 12.5" TUMBA  
 #535 Satin Black w/ Gold Hardware

**ELITE OAK BONGOS**  
 PBW300DXG 7" & 9"  
 #535 Satin Black w/ Gold Hardware

Also available in #532 Cherry Eucalyptus

## HAVANA SERIES

**HAVANA CONGAS**  
 PCF110HV651 11" Havana Quinto  
 PCF117HV651 11.75" Havana Conga  
 PCF125HV651 12.5" Havana Tumba

**HAVANA BONGOS**  
 PBF300HV651 7" & 9" Havana Bongos  
 #644 Liquid Gold or #651 Red Tiger Stripe

The stunning #644 Liquid Gold finish (right) and chrome plated hardware completes a set of drums you can love forever.

The wide belly shape of these high end, fiberglass drums produce deeper low tones and greater volume. Contour Crown rims and natural skin heads give you clear highs and cutting slaps.



The exotic #651 Red Tiger Stripe finish (below) is accented with gold plated hardware for a look that is as bold as the sound of the Havana Series.

## PRIMERO PRO

### PRIMERO PRO

Pearl's ever-popular Primero Pro congas and bongos are designed with professional features at an affordable price. Our expanded range of sizes offers 10" & 11" and 11.75" & 12.5" sets in both Thai Oak and Fiberglass with matching bongos.

### PRIMERO PRO FIBERGLASS

Primero Pro Fiberglass congas and bongos are available in: #621 Wine Red Marble, #626 Gold Marble, and #628 Blue Marble



PFC302DX628 11.75" & 12.5" Conga Set  
 #628 Blue Marble  
 Shown with matching bongos

PFC202DX621 10" & 11" Conga Set  
 #621 Wine Red Marble

PWC302DX621 12" Conga  
 #621 Wine Red Marble

### PRIMERO PRO OAK

Primero Pro Oak congas and bongos are available in: #511 Natural, #521 Midnight Fade, and #523 Carbon Vapor



PWB100DX523 7" & 8.5" Bongos  
 #523 Carbon Vapor

PWC302DX523 11.75" & 12.5" Congas  
 #523 Carbon Vapor

PFC302DX626 #626 Gold Marble

## PRIMERO

### PRIMERO OAK CONGA SETS

Primero Series congas and bongos are available with wood or fiberglass shells and in packages that include a double stand, single basket stands or without stands.

### PRIMERO OAK CONGA SETS

Primero Oak congas and bongos are available in: #511 Natural

\*Shown on PC300W Double Conga Stand PB700BHS Bongo Attachment sold separately

PFC202631 #631 Ebony



PWC202511 10" & 11" Conga Set\*  
 #511 Natural

PWB67511 6" & 7" Bongos  
 #511 Natural

### PRIMERO FIBERGLASS CONGA SETS

Primero Fiberglass congas are available in: #602 Bistre Black #631 Ebony



PFC204602 10" & 11" Conga Set  
 #602 Bistre Black

Shown on PC100P and PC110P Basket Stands

## FIELD PERCUSSION SERIES



PFC202EDU649 10" & 11" Congas  
 #649 Textured Black

## TRAVEL CONGAS



**TRAVEL CONGAS** Available in three standard sizes: 11" x 3.5", 11.75" x 3.5" and 12.5" x 3.5". They feature wood shells and stave construction and Remo FiberSkyn 3 synthetic heads. Five precision Allen bolts provide accurate and easy tuning via the included foam-handle wrench. The Travel Conga stand is designed specifically to be rock solid, and lightning fast during set-up and pack-up. The stand comes with a carrying bag that includes a pocket for the optional PPS50TC Bridge that connects two stands together to minimize creeping while performing.

aaaaa  
 PTC1100  
 PTC1175  
 PTC1250  
 PSC1175TC

11" Travel Conga  
 11.75" Travel Conga  
 12.5" Travel Conga  
 Travel Conga Bag

PC1100TC  
 PC1175TC  
 PC1250TC  
 PPS50TC

Stand for 11" w/ Carrying Bag  
 Stand for 11.75" w/ Carrying Bag  
 Stand for 12.5" w/ Carrying Bag  
 Stand Bridge



# CAJONS

*Get in the Cajon Zone!*

Cajons are the perfect introduction to the world of percussion. Affordable, easy to carry and just plain fun to play. Pearl offers a diverse collection of Cajons with a complete selection of accessories to customize your instrument and develop your own unique sound. Perfect for drum circles, small gigs or even studio work, your Cajon will become your new best friend.



19.75" T x 12.5" W x 12.5" D

**3D CAJON**  
PBC53D539  
Features a CNC cut wave design on both sides. Two sets of fixed snares are positioned near the top of the faceplate to increase the bass striking area. Black and Sea Blue finish.



19.75" T x 12.5" W x 12.5" D

**3D CAJON**  
PBC53D  
The 3D Cajon features 3D, CNC-cut graphics on the sides of the hardwood body. Internal snares are raised to create a larger bass strike zone. Inside the faceplate is coated with clear lacquer for a crispy snare response. Black and Natural finish.



19.75" T x 12.5" W x 12.5" D

**3D CAJON**  
PBC53D536  
Features a CNC cut tree design on both sides. Raised snares provide a larger bass strike zone. Black and Lime Green finish.

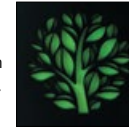

21" T x 12.5" W x 12.5" D

**TALL BOY CAJON**  
PCJ653  
This Fiberglass cajon is 21" tall and perfect for taller players or for use as a drum throne. It has fixed snares and a built-in bass port.  
Ebony Carubinga finish

100° Ergonomic Playing Position



19" T x 13" W x 13.25" D

**CENTIGRADE CAJON**  
PCJ650CG  
This Fiberglass cajon features a front faceplate with 100° of angle for less stress on your lower back. The molded rear bass port projects a full, rich bass tone.

#650 Mango Cherry Burst



19" T x 12.75" W x 12.5" D

**SAMBAJON**  
PCJ5BJ  
This Fiberglass cajon has two playing surfaces: a traditional hardwood front faceplate and a padded, cloth covered side that produces a Brazilian Surdo / "808" style bass tone. Perfect for use with any cajon pedal. Black Lacquer Finish



18.75" T x 12.5" W x 14" D

**CYCLONE CAJON**  
PCJ647CYC  
The 3D Cajon features 3D, CNC-cut graphics on the sides of the hardwood body. Internal snares are raised to create a larger bass strike zone. Inside the faceplate is coated with clear lacquer for a crispy snare response. Black and Natural finish



19.5" T x 12" W x 12" D

**MACH ONE\***  
PBC511M1  
Made in the USA, the Mach 1 cajon features tunable guitar wire snares, a Walnut faceplate and all Birch body. The rear facing bass port delivers deep, low end resonance.

Natural finish



18.75" T x 14" W x 14.5" D

**INNER CIRCLE MULTI DRUM CAJON**  
PCJ1C645  
Sit on top for standard cajon playing, or unlatch, remove and place drum on the closed cajon and play like a conga at a seated height. Or attach the accompanying strap and you have a shoulder-slung djembe or Timbao.  
#511 Natural Finish



**CAJH100**  
Cajon Holster Nylon w/ Velcro Straps



**PSCBC**  
Seat Cushion w/ Thick Foam for Comfort



18.5" T x 11.5" W x 11.5" D

**CLUB CAJON**  
PBC512CC  
The Club cajon features all wood construction with fixed snares and a rear facing bass port that deepens the lows.

#512 Sheer Black finish



19.75" T x 12.5" W x 13.5" D

**PRIMERO JINGLE\***  
PBC507JC  
The Primero Jingle is a wood version of the Jingle cajon and features built in Platanela and tambourine jingles that allow you to sound like an entire percussion section.

#507 Gypsy Brown finish



18.5" T x 14" W x 14" D

**WEDGE TRI-SIDE CAJON**  
PCJ3000B  
This unique pie slice shape offers a natural seated playing position and 2 striking surfaces. Fiberglass construction with fixed snares and Artisan II finish. Ported in rear.



19.75" T x 12.5" W x 12.5" D

**JESUS DIAZ SIG. RADIAL EDGE CAJON**  
PBC509JD  
In conjunction with world-renowned percussionist Jesus Diaz, Pearl has created the Radial Edge Cajon. Its high-end wood construction, fixed snares and luxurious Artisan Rosewood finish make this the ultimate cajon experience possible.



18.75" T x 12.5" W x 12.5" D

**BRUSH BEAT CAJON**  
PCJ633BT  
Fiberglass construction enhances the projection of this unique cajon. The black portion features a textured surface that responds well to brushes and other effects. Fixed snares provide a crisp response through the rear facing bass port.

Black and White Finish

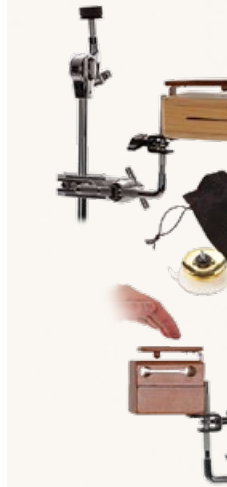

**PBCW100**  
Wood Block w/ Dual-Lock Tape & Mounting Bracket (PPS37 Not Included)



**PJCP1/6**  
Jingle Cup Two Pack Suction Cups Attach to the Cajon Face



**PBC100**  
Clave Block w/ Dual-Lock Tape & Mounting Bracket (PPS37 Not Included)



18.75" T x 12.5" W x 12.75" D

**BOOM BOX CAJON**  
PCJ633BB  
This Fiberglass cajon with fixed snares features a built in bass port that magnifies subsonic frequencies for great bass projection.

#633 Artisan Red Mahogany



19.75" T x 12.5" W x 12.5" D

**PRIMERO BOX CAJON\***  
PBC507  
Get started with Primero. Constructed from Asiatic Pine with fixed snares, this model has the right pitch and price.

#507 Gypsy Brown finish



18.75" T x 12.5" W x 12.75" D

**BOOM BOX CAJON**  
PCJ633BB630  
This Fiberglass cajon with fixed snares features a built in bass port that magnifies subsonic frequencies for great bass projection.

#630 Red Sparkle



18.75" T x 12.5" W x 13.25" D

**JINGLE CAJON**  
PCJ629  
This Fiberglass cajon features built in Platanela and tambourine jingles that can be engaged for incredible sound with fixed snares.

#629 Carubinga finish



19.5" T x 12" W x 12" D

**AFTERBURNER CAJON\***  
PBC511ABC  
Made in the USA. The Afterburner cajon features dual rear-firing ports that resemble the exhaust on a classic hot rod and delivers the same low end rumble. The 100% Birch body has a premium grain natural finish.

Dual Rear-Firing Ports



**PBCR1535**  
3 Way Cajon Riser First Lift = 21", Second Lift = 23", Third Lift = Angled Option



18.75" T x 14" W x 16" D

**SONIC BOOM FLAME THROWER CAJON\***  
PBC1914FT  
Made In The USA. Features a Flame Maple faceplate that adds a new voice to the Sonic Boom family. Two strategically placed bass ports are located at the top on the back to increase snare projection. Fiery Red and Natural Finish.



18.5" T x 14" W x 16" D

**SONIC BOOM\***  
PBC1914SB  
Made in the USA. Massive low-end producer perfect for small acoustic settings or larger amplified venues. 100% Birch construction provides exceptional resonance that speaks clearly through the frontward facing bass port. This Box Rocks!



18.5" T x 14" W x 16" D

**SONIC BOOM BUZZ\***  
PBC1914SBS  
Sister to the popular Sonic Boom, the Buzz adds fixed snares and a resonant Artisan Walnut front plate. This beautiful cajon really has the deep bass and punchy snare crack you need to emulate a drum set.



19" T x 14" W x 16" D

**MACH 3 CAJON\***  
PBC1914M3  
Made in the USA. The Mach 3 features a 100% Birch body with three isolated playing zones that simulate snare, bass and tom sounds. The backwards tilted front plate provides a comfortable playing position.



19.5" T x 12" W x 12" D

**MACH 2 CAJON\***  
PBC511M2  
Made In The USA. The Birch snare section of the faceplate creates a bright response while the Walnut bass section provides a punchy low end. An internal resonance plate prevents unwanted crosstalk between the sound chambers.  
#511 Natural Finish



13.75" T x 9.5" W x 10" D

**FUN BOX CAJON**  
PFB300  
Help your child develop proper playing mechanics while playing this smaller kid-friendly size cajon. Durable Fiberglass construction finished in bright yellow.

\*Available exclusively in the USA



# TIMBALES & RAINSTICKS

Build the Right Rig for the Gig!



MARC QUIÑONES  
DOOBIE BROTHERS

## TIMBALES

**PTSS134**  
PRIMERO TIMBALES  
13" / 14" Steel w/ Tilting Stand  
(Stands & Cowbell included)

**PTE1415DX**  
PRIMERO PRO TIMBALES  
14" / 15" Steel w/ Tilting Stand  
(Sticks included. Cowbell not included. Not available in Europe)

**PTE1336**  
PRIMERO 13"  
STEEL TIMBALE w/ PPS36 Mount

**PTE3131**  
FLAT TIMBALE w/ I.S.S. (Steel)

**PT900WS**  
TILTING TIMBALE STAND (Short)  
Height range 26.5" to 36.5"

**PBTB2418/C33**  
BANDA TAMBORA  
24" x 18" Bass w/ Cymbal Mount, Stand & Mallet

## RAINSTICKS

### BAMBOO RAINSTICKS WITH BURNED FINISH #694 RHYTHM WATER

**PBR SB60694**  
60" BAMBOO RAINSTICK

**PBR SB48694**  
48" BAMBOO RAINSTICK

**PBR SB40694**  
40" BAMBOO RAINSTICK

**PBR SB32694**  
32" BAMBOO RAINSTICK

**PBR SB24694**  
24" BAMBOO RAINSTICK

**PBR SB16694**  
16" BAMBOO RAINSTICK

Pearl is expanding its line of shakers to include six Bamboo rainsticks ranging in size from 16" to 60" and available in 2 unique finishes.

Pearl's natural Bamboo Rainsticks are 2.5" in diameter and feature an internal spiral maze of tines that a cascade of lava pebbles flow over to create the soothing sound of falling rain.

**PBR SP16693**  
16" BAMBOO RAINSTICK

**PBR SP24693**  
24" BAMBOO RAINSTICK

**PBR SP32693**  
32" BAMBOO RAINSTICK

**PBR SP40693**  
40" BAMBOO RAINSTICK

**PBR SP48693**  
48" BAMBOO RAINSTICK

**PBR SP60693**  
60" BAMBOO RAINSTICK

### BAMBOO RAINSTICKS WITH PAINTED FINISH #693 HIDDEN SPIRIT

## MARC QUIÑONES SIGNATURE TIMBALES



**ETE1415MQ**  
MARC QUIÑONES SIGNATURE TIMBALES  
14" / 15" Steel w/ Tilting Stand and PBL30 Clave Block (Cowbell not included)

## BANDA SERIES



**PBTM1516/C**  
BANDA TIMBALES  
15" / 16" Steel w/ Tilting Stand



HORACIO HERNANDEZ  
INDEPENDENT

Pearl and Grammy Award winning artist Horacio Hernandez have developed the ultimate family of cowbells. The HH4XH bell features a quick release system that allows the bell to lift easily off of its mount for hand held playing.

# COWBELLS

A Cowbell for Every Gig!

## HORACIO HERNANDEZ SIGNATURE COWBELLS



**HH5** MARYBELL  
**HH4XH** ISABELL QUICK RELEASE  
**HH4** HAND HELD CAMPANA  
**HH3** CHABELLA  
**HH2** CLABELL  
**HH1** BELLA

## NEW YORKERS BELLS



**PTB30** TRI-BELLS  
**ECB22** HAND-HELD AGOGO  
**ECB23** MOUNTED AGOGO  
**PTA30** TRI AGOGO  
**PDC60** PRO COWBELL BEATER  
**BCM3NY** CHA-CHA (High)  
**BCM5NY** CHA-CHA (Low)  
**BCM7NY** MAMBO  
**BCM8NYQ** MARC QUIÑONES SIG. TIMBALE BELL

MARVIN DIZ  
INDEPENDENT



RAFA PEREIRA  
JANELLE MONAE

## BALA BELLS



**BCM10** MOUNTED CAMPANA BELL  
**BCH10** HAND-HELD CAMPANA BELL

## PRIMERO COWBELLS



**PCB10GR** GUIRO COWBELL 8" BELL  
**PCB10MCR** 10" MILLENNIUM CHROME BELL  
**PCB1030** 10" BELL w/ PPS30  
**PCB6** 6" BELL  
**PCB4** 4" BELL

**PMTD9AKBF692**  
9 NOTE C AKE BONO  
#692 PURPLE BURST



Each drum features a 10" hardened steel shell with precise laser cut tongues for accurate and consistent tuning. Pearl Tongue drums can be played with your fingers or with a set of mallets included with each drum.



# TONGUE DRUMS

Awakening Series Tongue Drums.

Tongue drums derive their name from the tongue shaped areas where you strike the drum. The results are a cosmic blend of tones that are as much fun to hear as play. Pearl proudly introduces the Awakening Series of 6 Tongue Drums: Three 8 note and three 9 note drums tuned to pentatonic scales.

**PMTD8GMF687**  
8 NOTE G MAJOR  
#687 BLUE BURST

**PMTD8AKBF688**  
8 NOTE A AKE BONO  
#688 BROWN BURST

**PMTD8AMF689**  
8 NOTE A MINOR  
#689 GREEN BURST

**PMTD9LYDF690**  
9 NOTE C LYDIAN  
#690 ORANGE BURST

**PMTD9CPTF691**  
9 NOTE C MAJOR  
#691 CRIMSON BURST

**PMTD9AKBF692**  
9 NOTE C AKE BONO  
#692 PURPLE BURST



## DJEMBES

*Ancient Instruments  
For The Modern Percussionist.*

**DJEMBES** - Djembes are a traditional African instrument that offer a wide variety of sounds and are perfect for drum circles. The Professional Elite Series is available in Oak (12.5" diameter) and Fiberglass (12.5" and 14" diameter). All feature our Contour Crowns for comfortable playing and authentic Goat skin heads for deep lows and crisp highs.

#696 PURPLE HAZE



PBJV8696 8" TOP TUNED DJEMBE   PBJV10696 10" TOP TUNED DJEMBE   PBJV12696 12" TOP TUNED DJEMBE   PBJV14696 14" TOP TUNED DJEMBE   PBJV14697 14" TOP TUNED DJEMBE   PBJV12697 12" TOP TUNED DJEMBE   PBJV10697 10" TOP TUNED DJEMBE   PBJV8697 8" TOP TUNED DJEMBE

#697 TRIBAL FIRE

#698 ZEBRA GRASS



PBJVR7698 7" ROPE TUNED DJEMBE   PBJVR10698 10" ROPE TUNED DJEMBE   PBJVR12698 12" ROPE TUNED DJEMBE   PBJVR14698 14" ROPE TUNED DJEMBE   PBJVR14699 14" ROPE TUNED DJEMBE   PBJVR12699 12" ROPE TUNED DJEMBE   PBJVR10699 10" ROPE TUNED DJEMBE   PBJVR7699 7" ROPE TUNED DJEMBE

#699 MOLTEN SCARLET



PJW140R533 EZ TUNE DJEMBE 14" (OAK) #533 Gloss Black   PJW125R533 EZ TUNE DJEMBE 12.5" (OAK) #533 Gloss Black   PJF320R632 EZ TUNE DJEMBE 12" (FIBERGLASS) #632 Cranberry Fade   PJF350R632 EZ TUNE DJEMBE 14" (FIBERGLASS) #632 Cranberry Fade   PJF350FP649 FIELD PERCUSSION DJEMBE 14" (FIBERGLASS) #649 Textured Black Remo NuSkin Heads   PJW340 ELITE OAK DJEMBE 12.5" #511 Natural (Not available in Europe)   PJF350 14" ELITE FIBERGLASS DJEMBE #602 Bistre Black (Not available in Europe)   PFD300 FIBERGLASS FUN DRUM



PBJWR12695 12" HAND CARVED MAHOGANY DJEMBE #695 MALINKE VILLAGE



PBJSTD DJEMBE STAND • FITS 8" TO 14" PEARL ROPE TUNED AND TOP TUNED DJEMBES



PJBS350 DJEMBASS

**DJEMBASS** • If you want extreme low-end, and a head-turning alternative to a standard bass drum, look no further than to Pearl's Djembass. Convert our most popular PJF350 Fiberglass Djembe into a compact kick drum with the Djembass accessory pack. To reduce the attack and add greater "lows" we have included a cloth cap that stretches around the head. For greater low-end, slip the included neoprene disc inside which give you two sound options. Your pedal (not included) attaches via an I.S.S. type clamp to the Djembe's stand mounting plate.



PCW125FC TUMBADOR 12.5"   PCW110FC QUNITO 11"   PCW117FC SEGUNDO 11.75"   PBW300FC FOLKLORIC ELITE BONGOS 7" & 8.5"

#526 CRIMSON SUNRISE



PCA14FC CATA W/ HOLDER   PAC10FC ACHERE   PGT10FC GUATACA   PCL10FCB BAMBOO CLAVE   PCL20FCW WOOD CLAVE   PSK50FC UNO   PSK60FC SEGUNDO   PSK70FC CAJA

### BRAZILIAN PERCUSSION

Pearl's line of Brazilian Percussion brings modern refinements and Pearl quality to the traditional Samba musician. Our Repinique features lightweight yet sturdy steel shells with etched heads, shoulder straps and low rims for incredible playing comfort. The lightweight wood shell Surdos allow for hours of comfortable play when worn over the shoulder with the provided strap. Available in 18"x22", 20"x18" and 22"x22" sizes (diameter x depth), Pearl's popular Surdos continue to be the industry standard. The Timbao is made from lightweight fiberglass, and is capable of the extremely high tension utilized in tradition Brazilian ensembles. The Rocar is equipped with brass and steel platinellas, and can be played as a single shaker, or separated for two-handed sonic options.



PBTB140 TIMBAO   PBTA1420 TAN TAN   PBS2018 SURDO 20"   PBS1822 SURDO 18" (Shown with optional PBS30BD)   PBS2222 SURDO 22"



PBS30BD LEGS & BD ADAPTER KIT FOR SURDO

PBT70S TAMBORIM STICK

PBSM20 SURDO Mallet

PBRC80 ROCAR



PBCX1204 CAIXA 12"   PBCX1265 CAIXA 12"   PBC80SS CUICA   PBR10S REPINIQUE 10" w/ Strap   PBR12S REPINIQUE 12" w/ Strap



PBP510 PANDEIRO 10" (5 sets platinellas & goatskin head) w/ bag   PBP612 PANDEIRO 12" (6 sets platinellas & plastic head) w/ bag   PDZ510 PANDANZA w/ Agogo Bell   PBT60C TAMBORIM w/ Quick Draw Mount

## FOLKLORIC / BRAZILIAN

*Traditional Look, Modern Innovation.*

### FOLKLORIC ELITE CONGAS

Pearl's line of Folkloric congas feature a traditional look with modern innovation that only Pearl can deliver. Each 28" tall Oak conga is designed for the "seated" player, but is predrilled for stand mounts if necessary. Thicker South American style natural skins makes the drums warm sounding, but a fiberglass gel coat on the interior seals the shell and adds the projection and volume desired by today's players. Four Polished Steel Reinforcing Bands are inset on the shell for a smooth touch, and the traditional hoops complete these stunning instruments in a Matte Crimson Sunrise finish. The 7 & 8.5" Oak Bongos have the same hardware and shell features of the congas. The thicker bongo skins add to the projection and "dry" tone reminiscent of that classic Cuban sound.

**BATAS** Pearl Percussion Bata drums are available in Crimson Sunrise, the same beautiful finish featured on our Folkloric Elite congas and bongos. Additionally, the hardware is finished in Polished Steel and matches the hardware on our other tunable hand drums. These sacred ceremonial instruments have a thicker Enu (large) head for a deep, rich tone.



PBA60 ITOTELE   PBA50 OCONCOLO   PBA70 IYA



## CONCERT PERCUSSION

*Engineered For The Professional Percussionist.*

### CONCERT PERCUSSION

Pearl is proud to offer Concert Percussion instruments that are attractively priced for school ensembles, yet engineered with the professional percussionist in mind. The symphonic tambourine is a perfect example. Its 17 pairs of specially aged, stamped brass jingles provide a dry, yet bright tone that brings added color to any musical situation.

Its 10" headed wood frame allows the player to effortlessly perform all tambourine techniques, and the tambourine's plush carrying case is included. The rattler is another vital component to any concert percussionist's equipment, and Pearl's is built with an extended handle for a comfortable grip and ease of playing. Holders for the rattler and castanets are also available.



**PSFM16**  
16" OCEAN DRUM



**PCN20**  
CASTANETS (LONG HANDLE)



**PCN20S**  
CASTANETS



**PCN20H**  
CASTANETS HOLDER



**PSS100**  
SLAP STICK



**PCWB100** **PCWB200A** **PCWB300A**  
(High) (Medium) (Low)



**PPS12T**  
STIX-FREE TRIANGLE  
HOLDER w/ 8" Triangle



**PET100** **PET80** **PET60**  
10" TRIANGLE 8" TRIANGLE 6" TRIANGLE



**PTC10**  
TRIANGLE CLIP



**PTC300**  
TRIO TRIANGLE HOLDER



**PCWTB05** **PRT10**  
TEMPLE BLOCKS RATTLER



**PETM20**  
ELITE CONCERT  
TAMBOURINE



**PETM1017**  
SYMPHONIC  
TAMBOURINE



**PFR14C**  
14" FRAME DRUM



**PFR0818C**  
FRAME DRUMS SET OF 6  
Sizes: 8", 10", 12", 14", 16", 18"

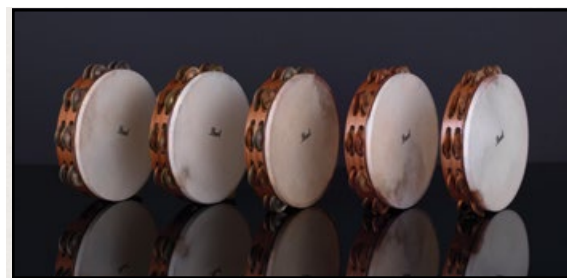

### ORCHESTRAL TAMBOURINES

The Pearl Orchestral Series Professional Tambourines provide performers a new voice and sound for any performing situation.

These 5 instruments feature uniquely sourced and hand-hammered jingles combinations of German Silver, Phosphor Bronze, Beryllium Copper, and Yellow Brass that give a full

spectrum of color and projection options to players. The 10" shell is a well-balanced and lightweight 2-ply Mahogany design with contoured hand-hold areas for comfortable performance and warm tone. The natural finish goatskin head provides a full responsive sound and traditional look without sacrificing durability. *Includes bag.*



**PETM1018CR**  
MIX COPPER AND BRASS

**PETM1018CB**  
MIX COPPER AND BRONZE

**PETM1018GC**  
MIX GERMAN SILVER AND COPPER

**PETM1018CP**  
BERYLLIUM COPPER

**PETM1018GS**  
GERMAN SILVER

NOTE: Items pictured are not to scale

## HAND PERCUSSION

*Ancient Instruments For The Modern Percussionist.*



**PNG20**  
NATURAL GOURD GUIRO



**PMG20**  
METAL GUIRO



**PFM20**  
BEADED MARACAS



**PFM50**  
MARACABASA



**PRM20**  
NATURAL HIDE MARACAS



**PGA20**  
BASKET GANZA 9" x 4"



**PGA60FP**  
21" FIELD PERCUSSION SHAKER



**PGA30W** (Short) **PGA32W** (Long) **PGA30** (Short) **PGA32** (Long)  
WOOD HEX GANZAS HEX GANZAS



**PGA40**  
TRIPLE SHAKER



**PGA60SF**  
GROOVE SHAKER



**PEC1**  
EGG CARTON



**PTM09BK**  
9" PRIMERO ROCK TAMBOURINE  
W/ MILLENNIUM JINGLES



**PTH10B** (Brass) **PTH10S** (Steel)  
HEADLESS WOOD TAMBOURINES



**PTM10GH**  
TAMBOURINE W/ BRASS JINGLES



**PTM10SH**  
STEEL JINGLE TAMBOURINE  
W/ STAINLESS STEEL JINGLES



**PTM50BHR** (Brass) **PTM50SHR** (Steel, not pictured)  
ULTRA GRIP VOLUME ADJUSTABLE TAMBOURINE



**CBS100**  
GATLING CABASA



**PTG20**  
TANG-TANG



**PAB20** **PAB50** **PAB100**  
(High) (Medium) (Low)



**PBL10** **PBL20** **PBL30**  
CLAVE BLOCK (High) CLAVE BLOCK (Medium) CLAVE BLOCK (Low)



**PWR40**  
SHAKELETS



**PSC30BR**  
SPIRIT CHIMES  
W/ HOLDER & Mallet



**PWCH3620A**  
36 ANODIZED ALUMINUM CHIMES  
WITH CASE, HOLDER AND STRIKER

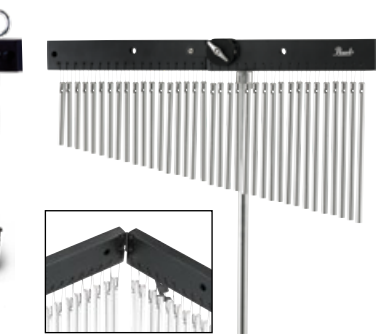

**PWCH3220G**  
32 GOLD ANODIZED ALUMINUM CHIMES  
WITH CASE, HOLDER AND STRIKER

**PWCHF3620AF**  
FOLDABLE 36 ANODIZED ALUMINUM CHIMES



# STANDS, BAGS, HOLDERS

Pro Tools for Every Gig.

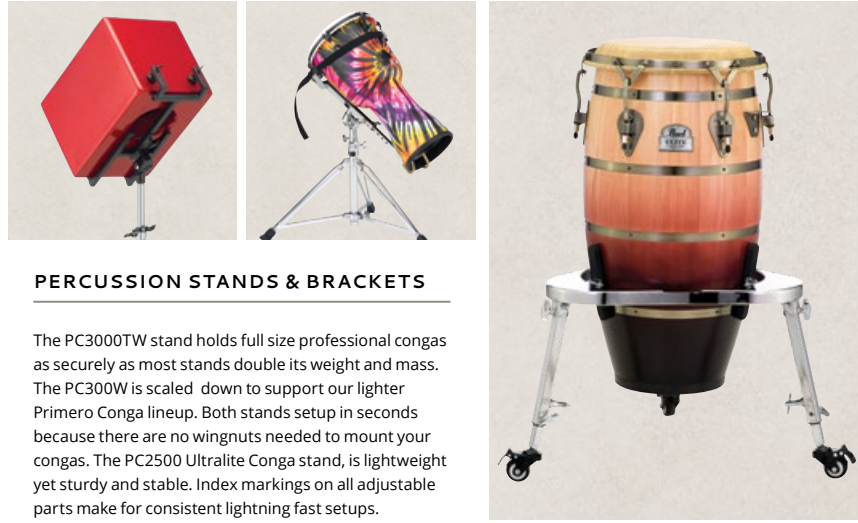

## PERCUSSION STANDS & BRACKETS

The PC3000TW stand holds full size professional congas as securely as most stands double its weight and mass. The PC300W is scaled down to support our lighter Primero Conga lineup. Both stands setup in seconds because there are no wingnuts needed to mount your congas. The PC2500 Ultralite Conga stand, is lightweight yet sturdy and stable. Index markings on all adjustable parts make for consistent lightning fast setups.

## CONGA STANDS



PC3000  
PRO CONGA STAND

PC3000TW  
QUICK RELEASE DOUBLE  
CONGA STAND W/ BAG

PC2500  
ULTRA LITE  
CONGA STAND

PC900  
ALL-FIT  
CONGA STAND

PC300W  
QUICK RELEASE  
DOUBLE CONGA STAND

PC200  
PRIMERO TWIN  
CONGA STAND

## BONGO STANDS



PB900LW  
ALL-FIT TILTING  
BONGO STAND

PB700  
LIGHTWEIGHT  
BONGO STAND

PB3000  
PRO ALL FIT  
BONGO STAND WITH SPRING  
LOADED STRAP HINGE



PB700BHS  
BONGO ATTACHMENT  
FOR PC200

## DJEMBE STANDS



PC800S  
ALL-FIT DJEMBE STAND

PD3000  
PRO DJEMBE STAND

## CAJON STANDS



PCJ70STD  
CAJON STAND

## BONGO STANDS

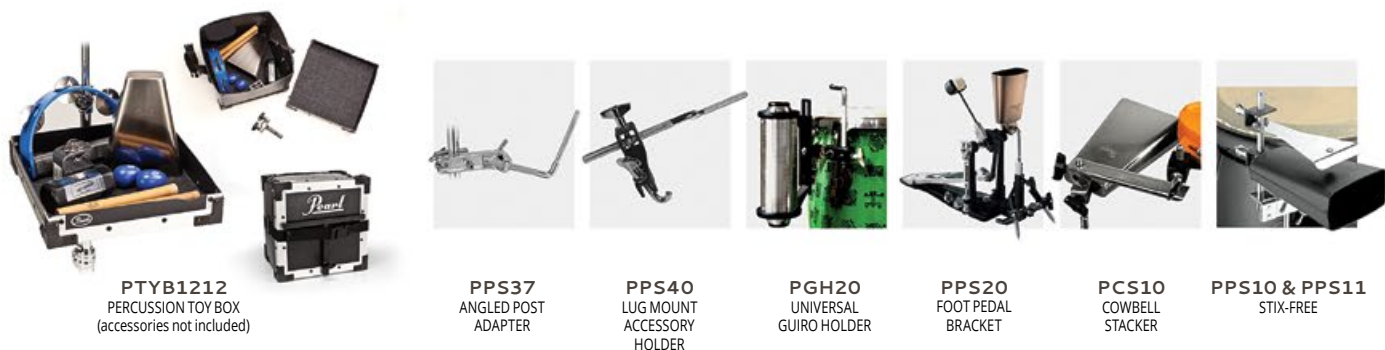

PTYB1212  
PERCUSSION TOY BOX  
(accessories not included)

PPS37  
ANGLED POST  
ADAPTER

PPS40  
LUG MOUNT  
ACCESSORY  
HOLDER

PGH20  
UNIVERSAL  
GUIRO HOLDER

PPS20  
FOOT PEDAL  
BRACKET

PCS10  
COWBELL  
STACKER

PPS10 & PPS11  
STIX-FREE

NOTE: Items pictured are not to scale

## TRAP TABLE & RACK

Our popular PTT1824 Trap Table can be easily converted into a two-level folding rack without drilling or modifications by simply adding the PTR1824 Add-On Rack. The PTR1824 installs in seconds using clamps and folds flush with the table for easy pack-up. A unique clamping system allows the included (4) straight and (4) angled 3/8" knurled posts to clamp anywhere onto horizontal or vertical areas of the rack. Also included is a retractable three-legged stabilizer bar for optimum stability. The easy-to-attach PTRUNV Universal Trap Table Rack mounts on virtually any trap table and features six 3/8" rods and receptors for various percussion mounting possibilities.



PTRUNV  
UNIVERSAL TRAP TABLE RACK  
(Table & stand sold  
separately from rack)

PTT8511  
TECH TRAY (8.5" x 11")

PTT1212  
TRAP TABLE (12" x 12")

PTR1824RC3  
TRAP TABLE SINGLE POST ADAPTER

## PERCUSSION CASES

Features include: ergonomic carrying straps, rubber protective bottoms, top-mounted carrying handles, tuning wrench pouches, & heavy duty double zippers.



PSCBC1213  
BASS CASE

PSC1213CJ  
BOX CAJON CASE  
13" x 14" x 20"

PSC1175TC  
TRAVEL CONGA CASE

PSC110CGW  
CONGA BAG - QUINTO  
FITS HAVANA SERIES

PSC117CGW  
CONGA BAG - CONGA  
FITS HAVANA SERIES

PSC125CGW  
CONGA BAG - TUMBA  
FITS HAVANA SERIES



PSCBB  
BONGO BAG

PSC125CG  
CONGA BAG  
12.5"

PSC117CG  
CONGA BAG  
11.75"

PSC110CG  
CONGA BAG  
11"

PSC140DJ  
DJEMBE BAG  
14"

PSC125DJ  
DJEMBE BAG  
12.5"

PBJCXL  
DJEMBE BAG  
12"

PBJCXXL  
DJEMBE BAG  
14"

## COWBELL HOLDERS

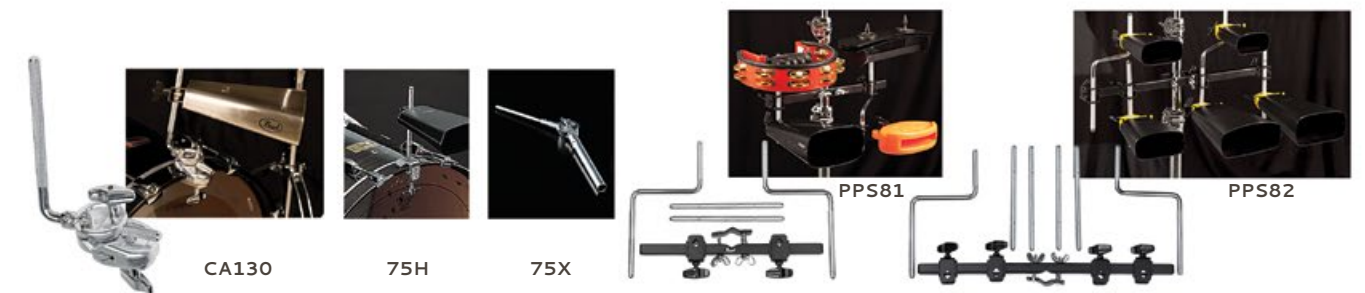

CA130

75H

75X

PPS81

PPS82



# REPLACEMENT PARTS

## ULTRA-SOUND SNARES

Pearl's Ultra-Sound snares feature patented Graduated Tension wires for extended dynamic range from ultra soft to ultra loud. Ultra-thin, low mass end plates assure ultra quick response. The end plates feature three mounting options: tunnels or holes for cord mounting and slots for straps. *US.PAT.7202405*



<b>SN1320C</b>	20 strands for 13", C-type, w/straps & cords
<b>SN1320D</b>	20 strands for 13", D-type, w/straps & cords
<b>SN1320I</b>	20 strands for 13", I-type, w/straps & cords
<b>SN1420C</b>	20 strands for 14", C-type, w/straps & cords
<b>SN1420D</b>	20 strands for 14", D-type, w/straps & cords
<b>SN1420I</b>	20 strands for 14", I-type, w/straps & cords



<b>SN1442C</b>	42 strands for 14", C-type, w/straps & cords
<b>SN1442D</b>	42 strands for 14", D-type, w/straps & cords
<b>SN1442I</b>	42 strands for 14", I-type, w/straps & cords

## REPLACEMENT SNARES



<b>S022N</b>	20 Strand for 14" w/Cords
<b>S022NU</b>	20 Strand for 14" w/Cords, Uncoated
<b>S022</b>	20 Strand for 14" w/Straps
<b>S025</b>	20 Strand for 14" long, w/Straps
<b>S029N</b>	20 Strand for 13" w/Cords
<b>S030N</b>	24 Strand for 14" w/Cords
<b>S031N</b>	20 Strand for 12" w/Cords
<b>S032N</b>	12 Strand for 10" w/Cords
<b>S033N</b>	12 Strand for 12" w/Cords
<b>S040</b>	15 Strand for 14" w/Cords, Steel Cable, Thinner Gauge
<b>S041</b>	15 Strand for 14" w/Cords, Bronze Cable, Thicker Gauge
<b>SPS18/6</b>	Plastic Strap (6/pkg)
<b>SNC40/6</b>	Snare Cord (6/pkg)

## OPTI-LOC

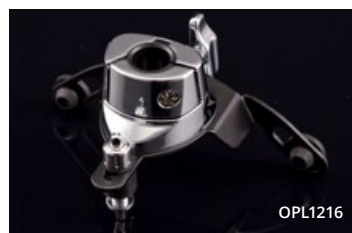

Opti-Loc suspension tom holders provide exceptional stability while greatly improving resonance and sustain. *(For EXX / EXL Export / DMP)*

<b>OPL0608/C</b>	Opti-Loc for EXX and DMP 6"-8" Diameter
<b>OPL1216/C</b>	Opti-Loc for EXX and DMP 12"-16" Diameter

## OPTIMOUNT

Our OptiMount Suspension System attaches to the tom's tension rods and floats on rubber cushions, providing the ultimate in stability while allowing the drum to resonate fully without restriction. With OptiMount, the mounting hardware is completely removed from the drum shell, providing a drastic improvement in resonance and sustain.



<b>OPTA0708/C</b>	for drums 7"-8" deep, 6"-16" diameter, Light Weight Aluminum	<b>OPT0708</b>	for drums 7"-8" deep, 8"-16" diameter, UltraGrip Wingnut
<b>OPTA0910/C</b>	for drums 9"-10" deep, 6"-16" diameter, Light Weight Aluminum	<b>OPT0910</b>	for drums 9"-10" deep, 8"-16" diameter, UltraGrip Wingnut
<b>OPTA1112/C</b>	for drums 11"-12" deep, 6"-16" diameter, Light Weight Aluminum	<b>OPT1112</b>	for drums 11"-12" deep, 8"-16" diameter, UltraGrip Wingnut
<b>OPTA1314/C</b>	for drums 13"-14" deep, 6"-16" diameter, Light Weight Aluminum	<b>OPT1314</b>	for drums 13"-14" deep, 8"-16" diameter, UltraGrip Wingnut
<b>OPTA1516/C</b>	for drums 15"-16" deep, 6"-16" diameter, Light Weight Aluminum	<b>OPT1516</b>	for drums 15"-16" deep, 8"-16" diameter, UltraGrip Wingnut

## MASTERCAST HOOPS

MasterCast are the finest die cast hoops available and feature the perfect blend of thickness and mass to improve the depth, clarity, and focus of toms and snare drums.



Model #	Diameter	# of Tension
<b>DC0805</b>	8"	5
<b>DC1006</b>	10"	6
<b>DC1206</b>	12"	6
<b>DC1306</b>	13"	6
<b>DC1408</b>	14"	8
<b>DC1408S</b>	14"	8 Snare Side
<b>DC1410</b>	14"	10
<b>DC1410S</b>	14"	10 Snare Side
<b>DC1410SG</b>	14"	10 Snare Side w/Guard
<b>DC1508</b>	15"	8
<b>DC1608</b>	16"	8
<b>DC1808</b>	18"	8

## BASS DRUM HOOP PROTECTORS



<b>HPP2</b>	Metal Hoop Protector for Wood BD Hoops
<b>NP01</b>	Hoop Protector for Metal BD Hoops
<b>NP347/2</b>	Non-Slip Hoop Protector for Wood BD Hoops (pair)

## SUPER HOOP II & FAT TONE HOOPS

SuperHoop II hoops are precision formed from heavy-duty 2.3mm steel, triple-flanged and engraved with the SuperHoop II logo. FatTone hoops are low mass 1.6mm hoops with hemmed and welded edges for strength and rigidity.



Super Hoop Model #	FatTone Hoop Model #	Diameter	# of Tension
<b>SH0604</b>	NA	6"	4
<b>SH0805</b>	FH0805	8"	5
<b>SH1006</b>	FH1006	10"	6
<b>SH1006S</b>	NA	10"	6 Snare Side
<b>SH1206</b>	FH1206	12"	6
<b>SH1208</b>	NA	12"	8 Snare Side
<b>SH1306</b>	FH1306	13"	6
<b>SH1308</b>	FH1308	13"	8
<b>SH1308S</b>	FH1308S	13"	8 Snare Side
<b>SH1408</b>	FH1408	14"	8
<b>SH1408S</b>	NA	14"	8
<b>SH1410B</b>	FH1410	14"	10
<b>SH1410S</b>	FH1410S	14"	10 Snare Side
<b>SH1410SG</b>	NA	14"	10 Snare Side w/Guard
<b>SH1508</b>	FH1508	15"	8
<b>SH1608</b>	FH1608	16"	8
<b>SH1808</b>	FH1808	18"	8

## STEEL HOOPS

Steel Hoop Model #	Diameter	# of Tension
<b>RH0804</b>	8"	4
<b>RH1006</b>	10"	6
<b>RH1206</b>	12"	6
<b>RH1306</b>	13"	6
<b>RH1408</b>	14"	8
<b>RH1408S</b>	14"	8 Snare side
<b>RH1608</b>	16"	8
<b>RH1808</b>	18"	8

## MASKING COVERS

The GK90 and BBC1 cover the holes of BT3 and BB3 brackets that have been removed.



<b>BBC1</b>	for BB3, w/Gasket, Screws and Nuts
<b>GK90</b>	for BT3, inside/outside plates w/Bolts

## SPIN-TIGHT™ TENSION RODS

Specially-designed stainless steel tension rods that lock to maintain tension settings. Starter pack includes 4 Spin-Tight Tension rods with K180 Drum Key.



<b>SPT5047</b>	W7/32 x 47mm (1)
<b>SPT4SPK</b>	W7/32 x 47mm (4) w/ K180 Drum Key
<b>SPT6PK</b>	W7/32 x 47mm (6)

## STAINLESS STEEL TENSION RODS

Pearl's Stainless Steel Tension Rods are machined, not forged, from a single piece of stainless steel to the most exacting tolerances in the industry. They feature super-smooth, precise tensioning, with absolutely no play. Each non-plated stainless steel tension rod is matched with a precision-machined brass swivel nut for ultra-precise performance.

<b>SST5028/6</b>	W7/32 x 28mm (6)
<b>SST5035/6</b>	W7/32 x 35mm (6)
<b>SST5038/6</b>	W7/32 x 38mm (6)
<b>SST5042/6</b>	W7/32 x 42mm (6)
<b>SST5047/6</b>	W7/32 x 47mm (6)
<b>SST5052/6</b>	W7/32 x 52mm (6)

## TENSION ROD WASHERS



<b>NLW12B/12</b>	Nylon Washers (12) Black
<b>MTW12/12</b>	Metal Washers (12)

## TENSION ROD LOCKNUTS



<b>TL20/10</b>	Tension Rod Lock Nuts (10/pkg)
<b>TNK10N/10</b>	Tension Keeper (10/pkg)

## CAMS & BEATER WEIGHT



<b>EPAP1</b>	Package: Beater Weight, Purple Cam, Yellow Cam
<b>BW100</b>	Beater Weight, 3 Weights in One ( <i>U.S. Patent #7122730</i> )

## P2000 SERIES CAMS

<b>CAMPL</b>	Eliminator Purple Cam, Aggressive Action
<b>CAMYL</b>	Eliminator Yellow Cam, Inverse Action
<b>CAMBK</b>	Eliminator Black Cam, Linear Action
<b>CAMWT</b>	Eliminator White Cam, Oversized Linear Action
<b>CAMBL</b>	Eliminator Blue Cam, Progressive Action
<b>CAMRD</b>	Eliminator Red Cam, Radical Action

## P2050 SERIES CAMS

<b>CAMPL</b>	Eliminator Purple Cam, Aggressive Action
<b>CAMYL</b>	Eliminator Yellow Cam, Inverse Action
<b>CAMTBK</b>	Eliminator Translucent Black Cam, Linear Action
<b>CAMTWT</b>	Eliminator Translucent White Cam, Oversized Linear Action
<b>CAMTBL</b>	Eliminator Translucent Blue Cam, Progressive Action
<b>CAMTRD</b>	Eliminator Translucent Red Cam, Radical Action

## CHAINS & BELTS



<b>CCA5</b>	Chain Assy Complete for Eliminator Pedals
<b>BCA1</b>	Belt Assy Complete for P2000 Eliminator Pedals
<b>BCA250</b>	Belt Assy Complete for P2050 Eliminator Pedals

## HI-HAT CLUTCHES



**RAPID LOCK HI-HAT CLUTCHES**  
Hi-Hat set-up and tear-down is a breeze with Rapid-Lock's Patented\* two-point quick release locking system.

<b>HCL205DQR</b>	Rapid Lock Quick Release Hi-Hat Drop Clutch w/ Locking Nut
<b>HCL205QR</b>	Rapid Lock Quick Release Super Grip Hi-Hat Clutch w/ Locking Nut
<b>HCL105QR</b>	Rapid Lock Quick Release Hi-Hat Clutch w/ Locking Nut <i>*U.S. Patent #9355625</i>

## DRUM KEYS

<b>KGT100</b>	Gyro Tune Key w/Quick Release
<b>K030</b>	Hi-Tension Tuning Key
<b>K080</b>	Tuning Key
<b>K180</b>	Spin-Tight Key

## MUFFLER

External clamp-on muffler for snare drums and toms. By adjusting the pressure and position of the felt pad, excessive overtones can be precisely controlled or eliminated.

<b>OM1</b>	Clamp-on Muffler, Snare Drum & Toms
------------	-------------------------------------

## QUICK RELEASE WINGLOC

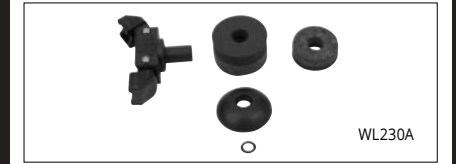

<b>WL230</b>	Quick Release WingLoc
<b>WL230A</b>	Quick Release WingLoc Complete

## DRUM HEADS

Model #	Size	Model #	Size
<b>MFH08</b>	8"	<b>MFH14</b>	14"
<b>MFH10</b>	10"	<b>MFH16</b>	16"
<b>MFH12</b>	12"	<b>MFH20B</b>	20"
<b>MFH13</b>	13"	<b>MFH22B</b>	22"

## BASS DRUM MUFFLER



## JUNGLE GIG CONVERSION



**JG16** • Pearl's Jungle Gig allows the conversion of a 16" Floor Tom to a Bass drum.

## PRACTICE PADS

### BASS DRUM PEDAL TRAINING PADS

**BD10**  
The BD10 bass pad is perfect for practicing at home or on the road. The wide pad accommodates double pedals and is specially formulated for extremely low noise and a realistic feel. The universal-fit "hoop" accepts all brands of pedals and adjusts to compensate for different floor surfaces. The BD10 folds for compact transport.





AARON SMITH - INDEPENDENT



ADRIAN BENT - DRAKE



AREJAY HALE - HALESTORM



BARRY KERCH - SHINEDOWN

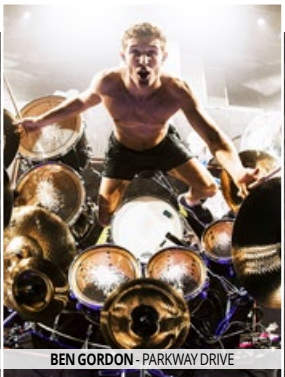

BEN GORDON - PARKWAY DRIVE



GABOR DORNYEI - THUNDERDUO, INDEPENDENT



GARY HUSBAND - INDEPENDENT



GENE HOGLAN - TESTAMENT / DETHKLOK



GEORGE KOLLIAS - NILE



HORACIO HERNANDEZ - LATIN LEGEND



BEN JOHNSTON - BIFFY CLYRO



BILLY HART - JAZZ LEGEND



BRIAN FRASIER-MOORE - JUSTIN TIMBERLAKE



BRUNO VALVERDE - ANGRA



CALEB GILBREATH - BRETT ELDRIDGE



HUBERT PAYNE - LITTLE BIG TOWN



IAN PAICE - DEEP PURPLE



JAMIE PERKINS - THE PRETTY RECKLESS



JASON BITTNER - OVERKILL



JASON BOWLD - BULLET FOR MY VALENTINE



CALVIN RODGERS - INDEPENDENT



CASEY COOPER - COOP3ERDRUMM3R



CHAD CROMWELL - JOE WALSH / SESSIONS



CHAD GRACEY - LIVE



CHAD SEXTON - 311



JASON HARTLESS - TED NUGENT



JASON PIERCE - OUR LADY PEACE



JEFF MARINO - DARIUS RUCKER



JEN LEDGER - SKILLET / LEDGER



JERROD "J-ROD" SULLIVAN - THE 4 KORNER



CHRIS RALLES - PAT BENATAR



DANI LOBLE - HELLOWEEN



DANIEL ERLANDSSON - ARCH ENEMY



DENA TAURIELLO - HEAD OVER HEELS (BROADWAY)



DENNIS CHAMBERS - DRUMMING LEGEND



JESSIE CARABALLO - MARC ANTHONY



JOCKE WALLGREN - AMON AMARTH

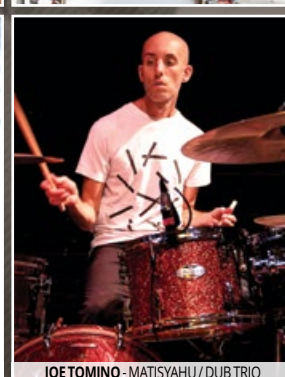

JOETOMINO - MATISYAHU / DUB TRIO



JOEY JORDISON - INDEPENDENT



JOEY KRAMER - AEROSMITH



DUSTIN STEINKE - SIXX.A.M.



ELISE TROUW - INDEPENDENT



ERIC SINGER - KISS



FLO MOUNIER - CRYPTOPSY



FREDO ORTIZ - GOGOL BORDELLO



JOHN LONGSTRETH - ORIGIN / HATE ETERNAL



JOHN WICKS - FITZ AND THE TANTRUMS



JON LARSEN - VOLBEAT



JONATHAN MOVER - INDEPENDENT



JOSH BAKER - MARIAH CAREY





JUAN "CARLITO" MENDOZA - INDEPENDENT



KAI HAHTO - NIGHTWISH



KEIO STROUD - BIG AND RICH



KENWOOD DENNARD - INDEPENDENT



KIKO FREITAS - INDEPENDENT



RAY LUZIER - KORN

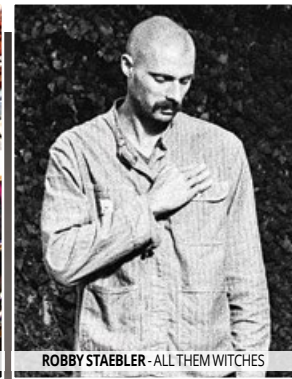

ROBBY STAEBLER - ALL THEM WITCHES

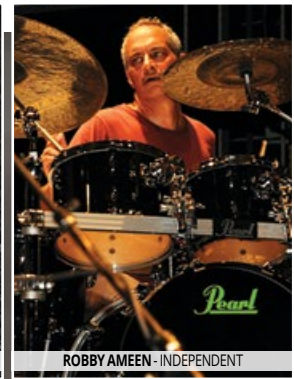

ROBBY AMEEN - INDEPENDENT



ROBERT ORTIZ - ESCAPE THE FATE



RODNEY HOWARD - AVRIL LAVIGNE



KRIS MYERS - UMPHREYS MC GEE



LENNY "THE OX" REECE - DJ PREMIER / SUPERDUPERKYLE



LESTER ESTELLE - KELLY CLARKSON / SESSIONS



MARCUS FINNIE - KIRK WHALLUM



MARVIN "SMITTY" SMITH - INDEPENDENT



RYAN MORAN - SLIGHTLY STOOPID



SAM LOEFFLER - CHEVELLE



SHANE GAALAAS - BZ / COSMOSQUAD

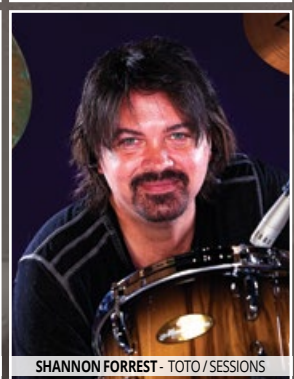

SHANNON FORREST - TOTO / SESSIONS



SHAUN FOIST - BREAKING BENJAMIN



MATT ABTS - GOVT MULE



MATT HALPERN - PERIPHERY



MELVIN BALDWIN - NEW EDITION / JOHNNY GILL



MICHAEL CARTELLONE - LYNRYD SKYNYRD



MICHELLE BAPTISTE - NORMANI K. HAMILTON



STAN BICKNELL - INDEPENDENT



TARON LOCKETT - CORY HENRY / THE FUNK APOSTLES



TAVARIUS JOHNSON - LALAH HATHAWAY



TERENCE HIGGINS - WARREN HAYNES / ANI DIFRANCO



TODD SUCHERMAN - STYX



MIGUEL LAMAS - INDEPENDENT



MIKE MANGINI - DREAM THEATER



MIKE WENGRN - DISTURBED



MORGAN ROSE - SEVENDUST



MORITZ MUELLER - THE INTERSPHERE, INDEPENDENT



TOM HURST - TOM HURST PRESENTS LOUD JAMZ / POWER TRIPLETS



TOMMY LEE - MOTLEY CRUE

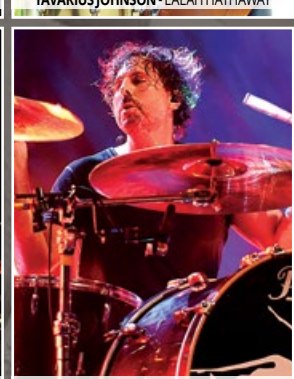

TONY PALERMO - PAPA ROACH



TRACY BROUSSARD - BLAKE SHELTON

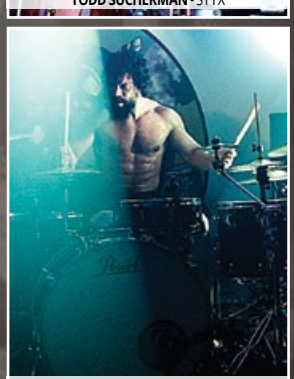

TRAVIS ORBIN - DARKEST HOUR / INDEPENDENT



NATE MORTON - THE VOICE



OMAR HAKIM - INDEPENDENT



PAUL KOEHLER - SILVERSTEIN



PETE WEBBER - HAVOK



QUINTON "Q" ROBINSON - AVERY'S SUNSHINE / ANTHONY DAVID



VITO REZZA - INDEPENDENT



WES LITTLE - INDEPENDENT

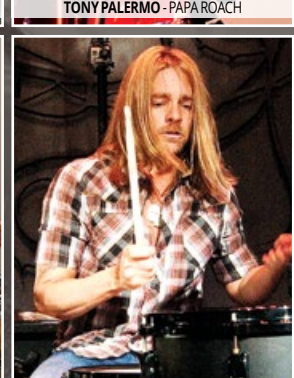

WILL HUNT - EVANESCENCE



WILL KENNEDY - YELLOWJACKETS



WUV - P.O.D.



# COLOR & CONFIGURATION CHART

## MASTERS MAPLE RESERVE A Classic Formula for Sonic Greatness.

PAGES 22 - 23

MRV924XEDP    MRV903XP    MRV923XSP    MRV943XP

22"x16" 10"x7" 12"x8"    20"x14" 12"x8"    22"x16" 12"x8"    24"x14" 13"x9"    16"x16"    14"x14"    16"x16"    16"x16"

## MASTERS MAPLE GUM Limited Edition. Unlimited Sound.

PAGES 24 - 25

MMG924XSP/C    MMG904XP/C

22"x16" 10"x7" 12"x8"    20"x14" 10"x7" 12"x8"    16"x16"    14"x14"

## MASTERS MAPLE COMPLETE The Masters Shell Comes Full Circle.

PAGES 26 - 27

MCT924XEDP/C    MCT903XP/C    MCT923XSP/C    MCT943XP/C

22"x16" 10"x7" 12"x8"    20"x14" 12"x8"    22"x16" 12"x8"    24"x14" 13"x9"    16"x16"    14"x14"    16"x16"    16"x16"

## SESSION STUDIO SELECT A Completely New Take on the Full Spectrum Sound.

PAGES 28 - 29

ST5925XSP/C    ST5944XP/C    ST5905XP/C

22"x16" 10"x7" 12"x8"    24"x14" 13"x9"    20"x14" 10"x7" 12"x8"    14"x14" (FREE)    16"x16"    18"x16" (FREE)    14"x14"    16"x16" (FREE)

HIGH GLOSS LACQUER  
PREMIUM DELMAR WRAP

## CRYSTAL BEAT The Original Seamless Acrylic Drum Shell.

PAGES 30 - 31

CRB543P/C    CRB524P/C    CRB525FP/C    CRB524FP/C    CRB503P/C

24"x14" 13"x9"    22"x16" 10"x7" 12"x8"    22"x16" 10"x7" 12"x8"    22"x16" 12"x8"    20"x15" 12"x8"    16"x16"    16"x15"    14"x13"    14"x13"    14"x13"    14"x13"

Individual components also available.  
For sizes, visit [www.pearldrums.com](http://www.pearldrums.com)

# COLOR & CONFIGURATION CHART

## DECADE MAPLE A Drum Kit 10 Years in the Making.

PAGES 32 - 33

DMP905P/C    DMP925SP/C    DMP943XP/C    DMP927SP/C

20"x16" 10"x7" 12"x8"    22"x18" 10"x7" 12"x8"    24"x14" 13"x9"    22"x18" 8"x7" 10"x7" 12"x8"    14"x5.5" 14"x14"    14"x5.5" 16"x16"    16"x16"    14"x5.5" 14"x14"    16"x16"

\*#234 only available in DMP925SP/C configuration

## EXPORT LACQUER The Legends of Tomorrow, Play Export Today.

PAGE 34

EXL725/C    EXL725S/C    EXL705N/C

22"x18" 12"x8" 13"x9"    22"x18" 10"x7" 12"x8"    20"x16" 10"x7" 12"x8"    14"x5.5" 16"x16"    14"x5.5" 16"x16"    14"x5.5" 14"x14"

## EXPORT The Best Selling Drum Set of All Time.

PAGE 35

EXX725/C    EXX725S/C    EXX705N/C

22"x18" 12"x8" 13"x9"    22"x18" 10"x7" 12"x8"    20"x16" 10"x7" 12"x8"    14"x5.5" 16"x16"    14"x5.5" 16"x16"    14"x5.5" 14"x14"

## MIDTOWN Big Gig, Small Rig, Huge Sound.

PAGE 36

MDT764P/C

16"x14" 10"x7"    13"x5.5" 13"x12"

## ROADSHOW JR For Beginning Drummers.

PAGE 37

RSJ465/C

16"x10" 8"x5" 10"x5.5"    12"x4" 13"x8"

## ROADSHOW It's Your Time To Play, Start The Right Way.

PAGE 37

RS525SC/C    RS525WFC/C    RS505C/C    RS584C/C

22"x16" 10"x8" 12"x9"    22"x16" 12"x9"    20"x16" 10"x7" 12"x8"    18"x12" 10"x7"    14"x5.5" 16"x16"    14"x6.5" 14"x14"    14"x5" 14"x14"    13"x5" 14"x10"



# COLOR & CONFIGURATION CHART

PAGES 12 - 15

## REFERENCE / REFERENCE PURE SPECIAL ORDER COLORS

Sonically Select Drum Performance / Unrestricted Tonal Response.

RF924XEDP/C    RF924XSP/C    RF903XP/C    RF923XSP/C    RF943XP/C  
RFP924XEDP/C    RFP924XSP/C    RFP903XP/C    RFP923XSP/C    RFP943XP/C

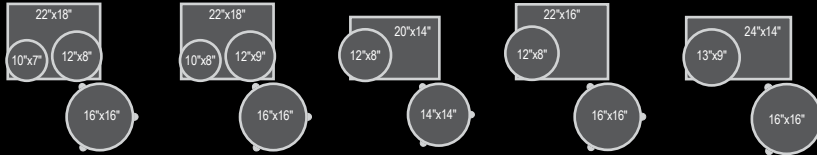

#100 WINE RED    #102 NATURAL MAPLE    #103 PIANO BLACK    #109 ARCTIC WHITE    #111 MATTE NATURAL    #126 EMERALD MIST    #128 VINTAGE SUNBURST

#142 ROOTBEER FADE    #143 TWILIGHT FADE    #151 PLATINUM MIST    #152 ANTIQUE GOLD    #155 SCARLET FADE    #197 RHYTHM BLUE    #302 INCA GOLD BURST

#329 BURNISHED BRONZE SPARKLE    #330 IVORY PEARL    #331 BLACK PEARL    #332 RED PEARL    #334 RED METALLIC    #335 BLACK CHERRY    #342 VINTAGE TOBACCO BURST (RFP Only)

#345 SATIN AUBURN    #355 ANTIQUE WALNUT    #356 TANGERINE DREAM    #376 ULTRA BLUE FADE    #377 SCARLET SPARKLE BURST    #393 PURPLE CRAZE II    #830 AUTUMN FADE SPARKLE

#831 MATTE OLIVE BURST    #832 SAPPHIRE BLUE SPARKLE    #833 EMERALD SPARKLE    #834 GLACIER BLUE SPARKLE    #835 AGED HONEYBURST

**PEARL CORPORATION**  
Corporate Headquarters

549 Metroplex Dr.  
P.O. Box 111240  
Nashville, Tennessee 37211-3140  
(615) 833-4477  
FAX (615) 833-6242

*Pearl*®

WWW.PEARLDRUM.COM

PGC2019



pearldrumsfan



PearlDrumCorp



pearl\_drums



PearlDrumCorp



pearldrumsforum.com